

Solenoid/pneumatic valves, ISO 15407-1

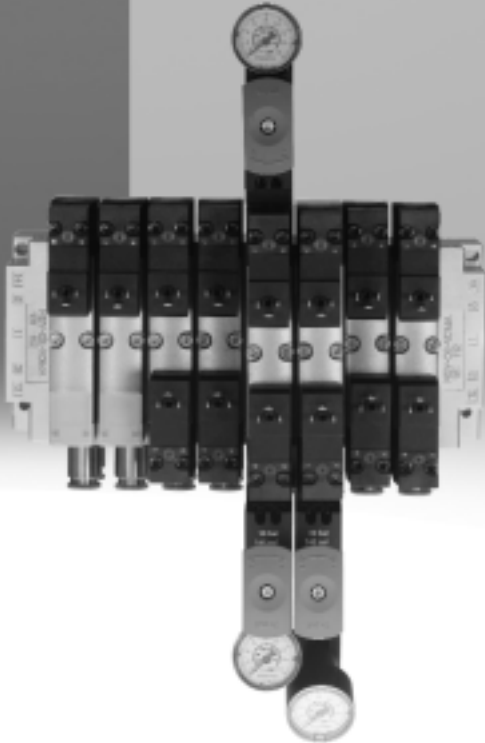

# Solenoid/pneumatic valves, ISO 15407-1

Key features

FESTO

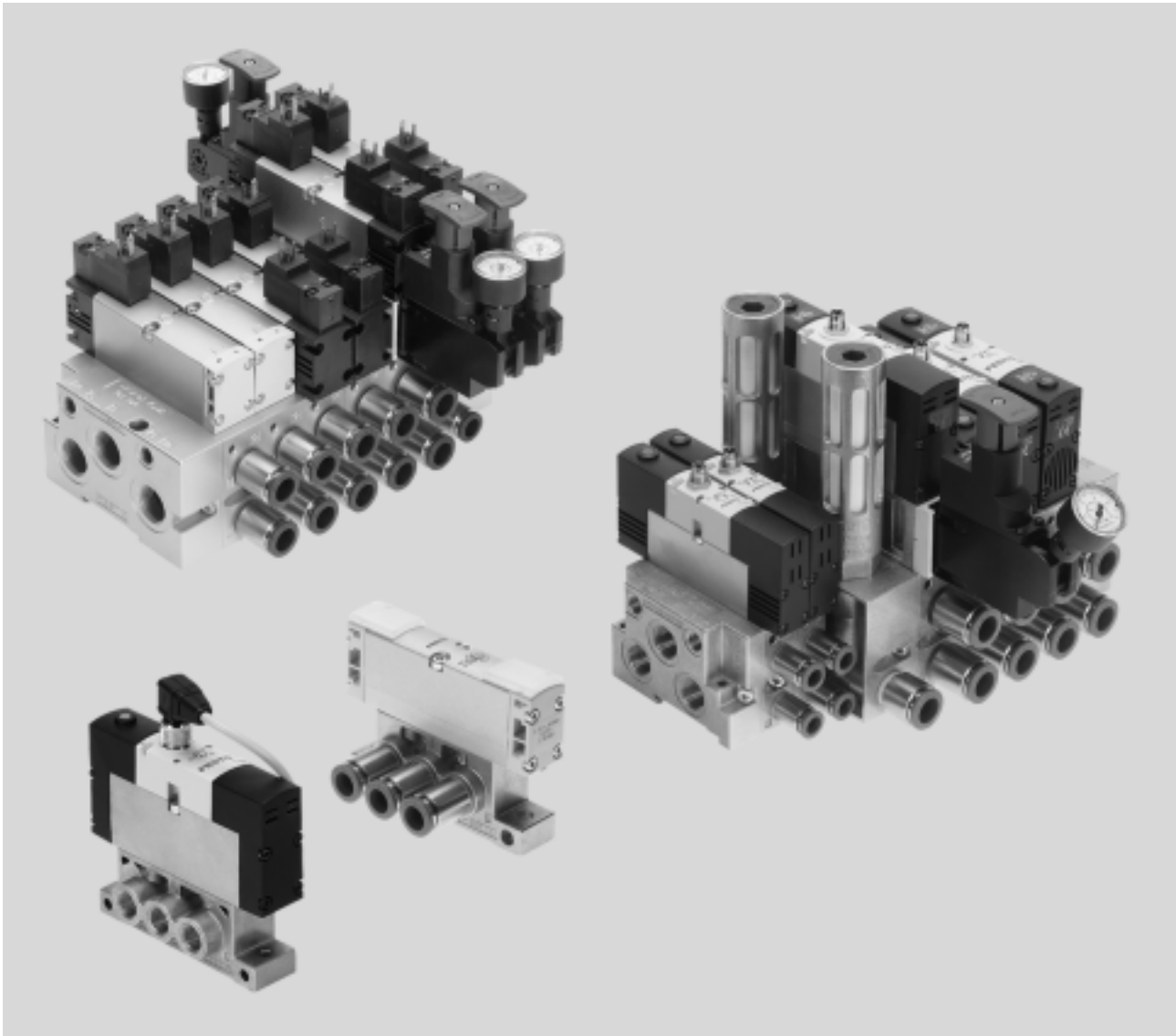

## Innovative

- High-performance valves in a sturdy metal housing
- Individual electrical connection via square round plug sockets
- Valve replacement under pressure possible using vertical pressure shut-off plate
- Reverse operation
- Vacuum operation

## Versatile

- Modular system offering a range of configuration options
- Easy to convert or extend at a later date
- Integration of innovative function modules possible
  - Regulator plate
  - Flow control plate
  - Vertical pressure shut-off plate
  - Vertical supply plate
- Vertical supply plates permit a flexible air supply and variable pressure zones
- Wide range of valve functions
- Extensive operating voltage range from 12 V DC to 230 V AC

## Reliable

- Sturdy and durable metal components
  - Valves
  - Horizontally linked sub-bases
  - Vertically stacked sub-bases
- Fast troubleshooting thanks to LEDs
  - in the plug socket or
  - in the illuminating seal or
  - in the valve
- Convenient servicing thanks to valves that can be replaced quickly and easily
- Manual override
- Durable thanks to tried-and-tested piston spool valves

## Easy to install

- Secure mounting on wall or H-rail
- Combi manifolds of width 18 mm and 26 mm
- Plug-in pressure gauges on the regulator plate

# Solenoid/pneumatic valves, ISO 15407-1

Key features

## Single valve manifold VTIA

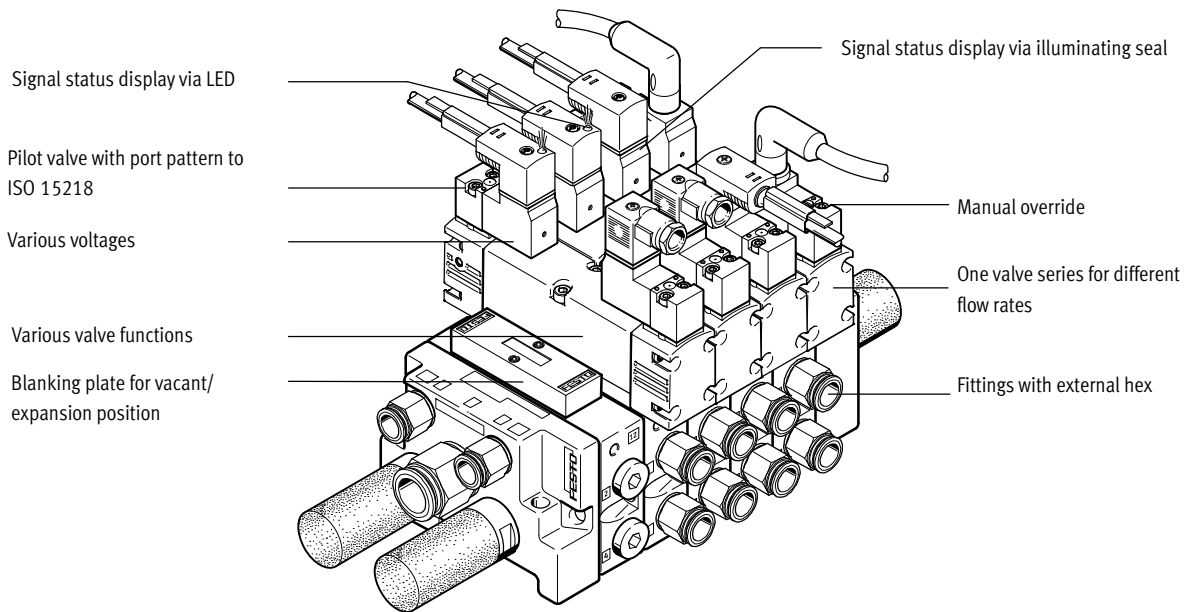

## Equipment options

### 5/2-way valve

- Single solenoid, pneumatic or spring return
- Double solenoid valve
- Double solenoid valve with dominance at 14

### 2x 3/2-way valve, single solenoid

- Normally open
- Normally open, reversible (on request)
- Normally closed
- Normally closed, reversible (on request)

- 1x normally open, 1x normally closed
- 1x normally open, 1x normally closed, reversible (on request)

### 5/3-way valve

- Mid-position valve
  - Normally open
  - Normally closed
  - Normally exhausted

### 2x 2/2-way valve, single solenoid

- Normally closed

## Special features

### Operation with external pilot air supply

- For vacuum applications
- For operating pressure of less than 3 bar
- For significant pressure fluctuations in the power section. Power section and pneumatic control section are isolated
- For heavily lubricated air in the power section
- For manifolds if the pressure zones are created via ducts 3 and 5 (not possible with 2x 3/2)
- For manifolds or pressure zones that are equipped with reversible 2x 3/2-way valves (valves on request)

### Operation with internal pilot air supply

- For small pressure fluctuations in the power section
- For using pressure regulator plates in a vertical stacking construction, also in reverse operation
- As a low-cost solution

### Reverse operation with compressed air supply via ducts 3 and 5

- Pressure zone separation via ducts 3 and 5
  - Example: duct 3 vacuum, duct 5 ejector pulse
  - Example: duct 3 high pressure for advancing the piston rod of a double-acting cylinder. Duct 5 low pressure for retracting the piston rod with low energy consumption
- 2x 3/2-way valves used as 5/4-way valve with controllable overlapping and pressure zone separation with the reversible variant

### Reverse operation with a pressure regulator plate, compressed air supply via duct 1

- Reversible pressure regulator combined with a reversible 2x 3/2-way valve regulates outputs 2 and 4
  - AB regulator for each of outputs 2 and 4
  - A regulator for output 4
  - B regulator for output 2
- Reversible pressure regulators are in the control position immediately after the power supply is switched on
  - Adjustment possible at all times
  - Dynamic response characteristics
  - Reduced regulator load because the supply pressure is maintained when the valve is switched
  - Not exhausted via the regulator

# Solenoid/pneumatic valves, ISO 15407-1

Key features

FESTO

## Valve manifold VTIA with combination of sizes and vertical stacking

Solenoid valve with individual pilot valves and pneumatic interface to ISO 15218. Can be connected with square plug sockets or round plugs

Widths of 18 mm and 26 mm can be combined

Solenoid valve with central round plug

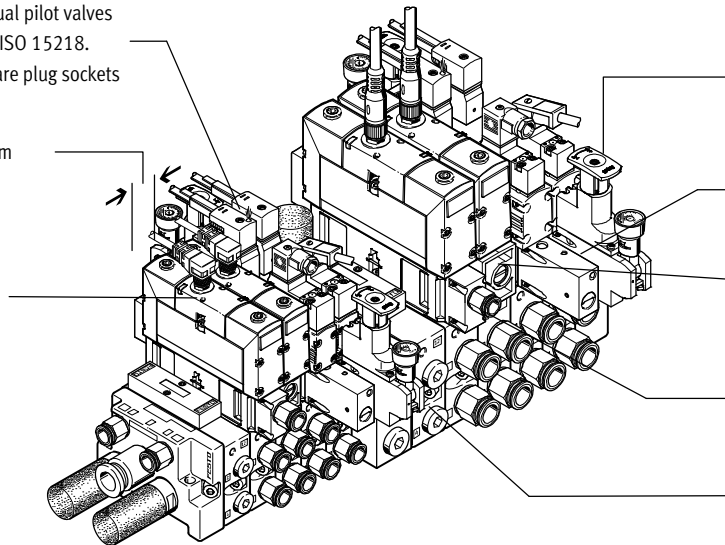

Pressure regulator for setting the force of the actuated drive

Pressure shut-off plate for replacing valves during operation

Flow control plate in the valve manifold for adjusting the speed of the drive

Supply plate for compressed air supply of a control chain as a separate pressure zone

Intermediate plate as interface between width 18 mm and width 26 mm

## Vertical stacking function

### Pressure regulator valve

- Single variant to regulate the pressure at output 4(A) or 2(B) or at input 1(P)
- Dual variant to regulate the pressure at output 4(A) and 2(B) individually
- Reverse variant for the outputs so that the regulator is in the control position
- With pressure gauge connection

### Flow control plate

- Designed with two flow control valves for adjusting the exhaust air flow rate at exhausts 5 or 3. This allows the drive to be set in motion and the desired speed to be set at the manifold using the manual override.

### Vertical pressure shut-off plate

- Equipped with a switch via which the compressed air supply can be shut off. A directional control valve or subsequent vertical stacking plate can thus be replaced without switching off the overall air supply
- If the control chain has a redundant design, the cycle can continue even with cyclical control

### Vertical supply plate

- As additional air supply for a valve
- To supply a third pressure zone

## Individual connection with square plug, type C

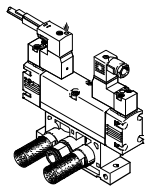

The directional control valve has a pilot control to ISO 15218 and a plug pattern to EN 175301-803, type C.

## Individual connection with central round plug

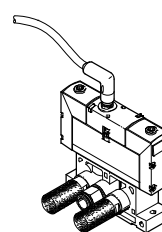

The electrical connection is established using a standardised M12- or M8 socket 24 V DC (EN 61076-2-101).

# Solenoid/pneumatic valves, ISO 15407-1

Key features

FESTO

## Single valve manifold VTIA, directional control valves with square plug, type C

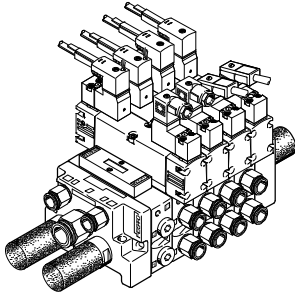

### Design

- Width 26 mm
- Vacant position
- Compressed air supply via duct 1
- External pilot air supply
- With fittings
- Venting via silencer for ducts 3 and 5

## Single valve manifold VTIA, pressure zones via duct 3 and 5

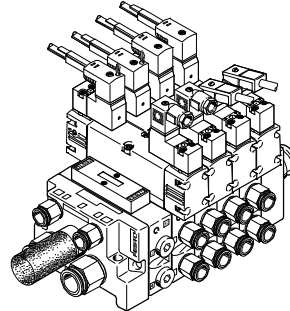

### Design

- Width 26 mm
- Vacant position
- Compressed air supply via ducts 3 and 5
- External pilot air supply
- With fittings
- Venting via silencer

## Valve manifold VTIA fitted with width 18 mm and 26 mm, directional control valves with square plug, type C

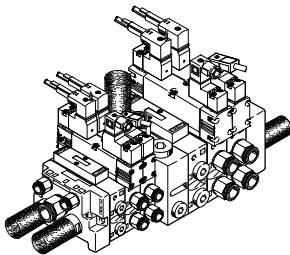

### Design

- Width 18 mm and 26 mm combined via intermediate plate
- Vacant position
- Compressed air supply via duct 1
- External pilot air supply
- With fittings
- Venting via silencer for ducts 3 and 5 on the end plates and for duct 3 also on the intermediate plate

## Valve manifold VTIA fitted with width 18 mm and 26 mm, directional control valves with central round plug

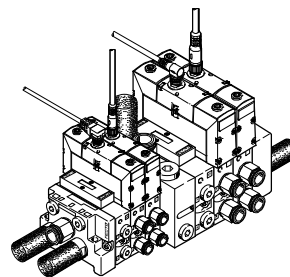

### Design

- Width 18 mm and 26 mm combined via intermediate plate
- Vacant position
- Compressed air supply via duct 1
- Internal pilot air supply
- With fittings
- Venting via silencer for ducts 3 and 5 on the end plates and for duct 3 also on the intermediate plate

## Valve manifold VTIA with maximum expansion with all vertical stacking modules

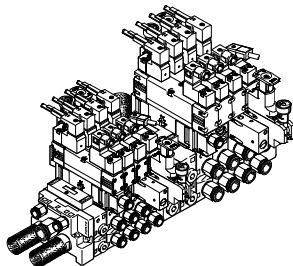

### Design

- Width 18 mm and 26 mm combined via intermediate plate
- Directional control valves with square plug
- Pressure regulators
- Flow control plates
- Shut-off plates
- Supply plates with vacant position

## Pneumatically actuated directional control valve on individual sub-base

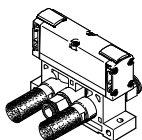

Directional control valves on an individual sub-base can be used for drives that are further away from a valve manifold or when there is only one drive available.

## Valve manifold VTIA fitted with width 18 mm and 26 mm, with pneumatically actuated directional control valves

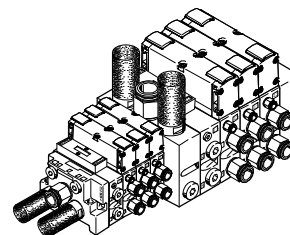

### Design

- Width 18 mm and 26 mm combined via intermediate plate
- Vacant position
- Compressed air supply via duct 1
- With fittings
- Venting via silencer for ducts 3 and 5 on the end plates and for ducts 3 and 5 also on the intermediate plate

# Solenoid/pneumatic valves, ISO 15407-1

Key features

FESTO

## Solenoid valves with square plug, type C

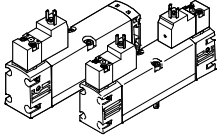

Versions

- Width 18 mm and 26 mm
- 2x 2/2-way, 2x 3/2-way, 5/2-way and 5/3-way valves
- 2x 3/2-way valves for reverse operation
- Internal or external pilot air supply available
- 12, 24 V DC, 24, 110 or 220 V AC

## Solenoid valves with central round plug

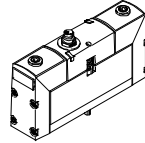

Versions

- Width 18 mm and 26 mm
- 2x 3/2-way, 5/2-way and 5/3-way valves
- Internal or external pilot air supply available
- 24 V DC

## Basic valves with interface to ISO 15218

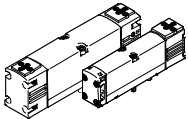

Versions

- Width 18 mm and 26 mm
- 2x 2/2-way, 2x 3/2-way, 5/2-way and 5/3-way valves
- Internal or external pilot air supply available

## Solenoid valves with M12 round plug

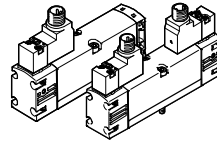

Versions

- Width 18 mm and 26 mm
- 2x 2/2-way, 2x 3/2-way, 5/2-way and 5/3-way valves
- 2x 3/2-way valves for reverse operation
- Internal or external pilot air supply available
- 24 V DC

## Pilot valve with interface to ISO 15218

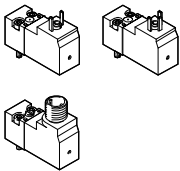

Versions

- With square plug, type C or M12 round plug
- For 12, 24 V DC and 24 V AC without protective earth conductor
- For 110 and 220 V AC with protective earth conductor
- 3/2-way valve
- Manual override non-detenting or non-detenting/detenting

## Pneumatically actuated directional control valves

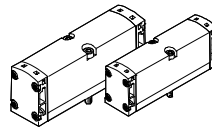

Versions

- Width 18 mm and 26 mm
- 2x 3/2-way, 5/2-way and 5/3-way valves
- Signal inputs 12 and 14 via the sub-base

## Individual sub-base

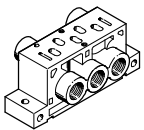

Versions

- Width 18 mm and 26 mm
- Ports 12 and 14 for external pilot air supply for solenoid valves and
- Ports signal inputs 12 and 14 for pneumatically actuated valves are the same

## Blanking plate for unused valve position

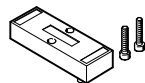

Versions

- Width 18 mm and 26 mm

## End plate kit

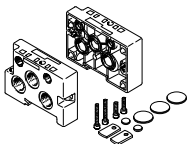

Versions

- Widths 18 mm and 26 mm
- Ports 12 and 14 for external pilot air supply for solenoid valves
- For pneumatically actuated valves the signal inputs are only on suitable manifold sub-bases

## Manifold sub-base/series sub-base

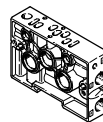

Versions

- Widths 18 mm and 26 mm
- For solenoid valves
- For pneumatically actuated valves with additional ports for the signal inputs

## Intermediate plate

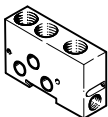

Design

- Adapter between width 18 mm and 26 mm
- With additional air supply and exhaust ports

## Intermediate plate kit

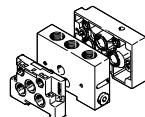

Design

- Intermediate plate as adapter between width 18 mm and 26 mm
- One 18 mm and one 26 mm end plate

# Solenoid/pneumatic valves, ISO 15407-1

Key features

FESTO

## Pressure regulator plate with one pressure regulator

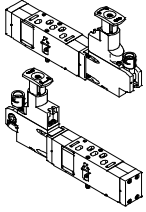

### Versions

- Widths 18 mm and 26 mm
- For pressure regulation at supply input 1 (P). Set pressure is the same for outputs 2 and 4
- For pressure regulation at working port 4 (A)
  - The pressure regulator for reverse operation is supplied via port 1 of the sub-base and supplies port 5 on the directional control valve
  - The directional control valve vents via port 1 to ports 3 and 5 of the sub-base
- For pressure regulation at working port 2 (B)
  - Input 3 is supplied here in reverse operation

## Pressure regulator plate with two pressure regulators

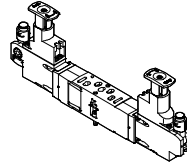

### Versions

- Widths 18 mm and 26 mm
- For pressure regulation at working ports 4 (A) and 2 (B)
  - The pressure regulators for reverse operation are supplied via port 1 in the sub-base and feed inputs 5 and 3 on the directional control valve
  - The directional control valve vents via port 1 to ports 3 and 5 of the sub-base

## Vertical supply plate

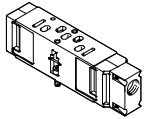

### Versions

- Widths 18 mm and 26 mm
- As intermediate supply
  - For one valve
  - To supply a third pressure zone
- Can be equipped with a directional control valve

## Flow control plate

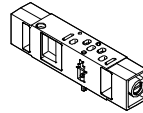

### Versions

- Widths 18 mm and 26 mm
- Exhaust air restrictors in ducts 3 and 5
  - In the case of pressure zones that are formed by ducts 3 and 5, the flow control plates act as supply air restrictors

## Vertical pressure shut-off plate

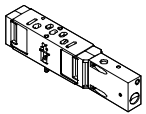

### Versions

- Widths 18 mm and 26 mm
- A switch activated with a slotted head screwdriver shuts off duct 1
  - The overlying flow control plates, pressure regulator plates or directional control valves can be replaced
  - Other components of the control chain such as drives, for example, can be replaced following venting via the directional control valve

## Pressure gauge



### Design

- Can be connected to the pressure regulator plates

# Solenoid/pneumatic valves, ISO 15407-1

Key features

FESTO

## Port pattern on sub-base to ISO 15407-1

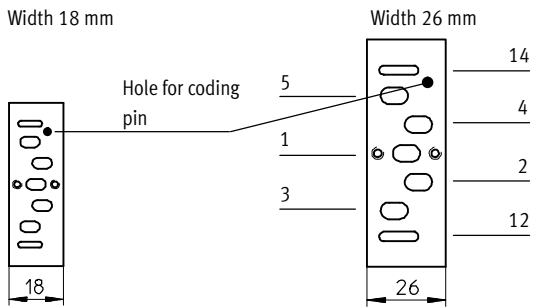

## VSVA

### Conversion of pilot air exhaust

The valve manifold VTIA is supplied with unducted pilot air exhaust. By turning the seal between the valve

and manifold block, exhaust air (pilot air) can be diverted into pilot duct 12 and can thus be contained and silenced (see illustration).

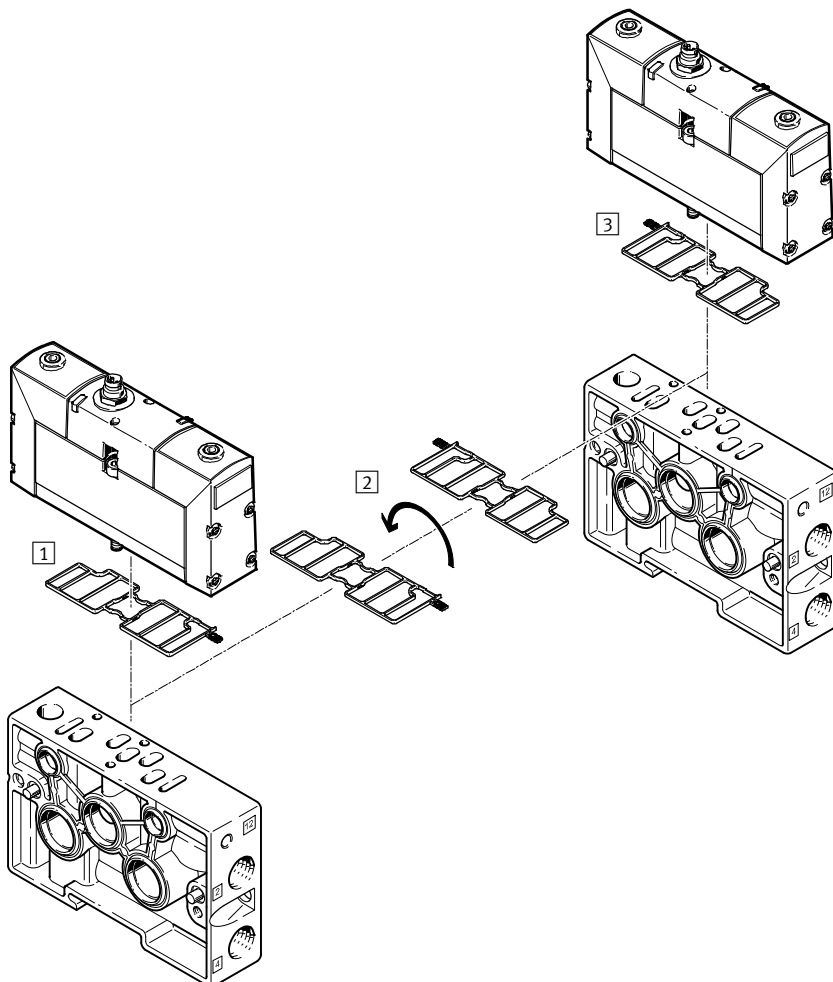

- 1 Ducted pilot air exhaust
- 2 Turning the seal by 180°
- 3 Unducted pilot air exhaust (as supplied)









# Solenoid/pneumatic valves, ISO 15407-1

Key features

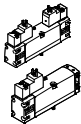
Use of 2x 3/2-way valve as 5/4-way valve																			
Code	Circuit symbol	Value table	Equivalent circuit symbol	Function															
K		<table border="1"> <thead> <tr> <th>Y1</th> <th>Y2</th> <th>A</th> </tr> </thead> <tbody> <tr> <td>0</td> <td>0</td> <td></td> </tr> <tr> <td>0</td> <td>1</td> <td></td> </tr> <tr> <td>1</td> <td>0</td> <td></td> </tr> <tr> <td>1</td> <td>1</td> <td></td> </tr> </tbody> </table>	Y1	Y2	A	0	0		0	1		1	0		1	1			<ul style="list-style-type: none"> <li>• Normally exhausted</li> <li>• The double-acting drive connected to outputs 2 and 4 is unpressurised when the valve is in the normal position and can be moved by an external force</li> <li>• If there is a signal present at Y1(14) and Y2(12), there is pressure at outputs 2 and 4</li> </ul>
Y1	Y2	A																	
0	0																		
0	1																		
1	0																		
1	1																		
		<table border="1"> <thead> <tr> <th>Y1</th> <th>Y2</th> <th>A</th> </tr> </thead> <tbody> <tr> <td>0</td> <td>0</td> <td></td> </tr> <tr> <td>0</td> <td>1</td> <td></td> </tr> <tr> <td>1</td> <td>0</td> <td></td> </tr> <tr> <td>1</td> <td>1</td> <td></td> </tr> </tbody> </table>	Y1	Y2	A	0	0		0	1		1	0		1	1			<ul style="list-style-type: none"> <li>• Normally closed (by combining directional control valve code K and two piloted non-return valves)</li> <li>• The piloted non-return valves connected to outputs 2 and 4 are unpressurised when the valve is in the normal position and the pressures in the drive close the non-return valves so it is leak-tight</li> <li>• The drive remains stationary when the forces are in equilibrium</li> <li>• Leakages can only occur via the drive seals</li> <li>• If there is a signal present at Y1(14) and Y2(12), the same pressure is present at outputs 2 and 4</li> </ul>
Y1	Y2	A																	
0	0																		
0	1																		
1	0																		
1	1																		
N		<table border="1"> <thead> <tr> <th>Y1</th> <th>Y2</th> <th>A</th> </tr> </thead> <tbody> <tr> <td>0</td> <td>0</td> <td></td> </tr> <tr> <td>0</td> <td>1</td> <td></td> </tr> <tr> <td>1</td> <td>0</td> <td></td> </tr> <tr> <td>1</td> <td>1</td> <td></td> </tr> </tbody> </table>	Y1	Y2	A	0	0		0	1		1	0		1	1			<ul style="list-style-type: none"> <li>• Normally open</li> <li>• The double-acting drive connected to outputs 2 and 4 is supplied with the same compressed air at both ends when the valve is in the normal position and stops when the forces are in equilibrium</li> <li>• If there is a signal present at Y1(10) and Y2(10), outputs 2 and 4 are exhausted, the drive is unpressurised and can be moved by an external force</li> </ul>
Y1	Y2	A																	
0	0																		
0	1																		
1	0																		
1	1																		
H		<table border="1"> <thead> <tr> <th>Y1</th> <th>Y2</th> <th>A</th> </tr> </thead> <tbody> <tr> <td>0</td> <td>0</td> <td></td> </tr> <tr> <td>0</td> <td>1</td> <td></td> </tr> <tr> <td>1</td> <td>0</td> <td></td> </tr> <tr> <td>1</td> <td>1</td> <td></td> </tr> </tbody> </table>	Y1	Y2	A	0	0		0	1		1	0		1	1			<ul style="list-style-type: none"> <li>• Normally open after output 2</li> <li>• The double-acting drive connected to outputs 2 and 4 is supplied with compressed air via output 2 when the valve is in the normal position. Output 4 is exhausted. When the system is in its initial position, the drive is thus in a clearly defined position, as would also be the case with a 5/2-way single solenoid valve</li> <li>• If there is a signal at Y1(14) and Y2(10), output 2 is exhausted and there is pressure at output 4. The drive leaves the initial position</li> <li>• A closed circuit can be created with this 2x 3/2-way valve by combining it with piloted non-return valves. However, this is then selected by an active signal at Y2(10)</li> </ul>
Y1	Y2	A																	
0	0																		
0	1																		
1	0																		
1	1																		

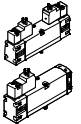
# Solenoid/pneumatic valves, ISO 15407-1

Product range overview

Function	Type	Valve function	Flow rate Valve [l/min]	Working line on the sub-base		Operating voltage					
				G $\frac{1}{8}$	G $\frac{1}{4}$	[V DC]		[V AC]			
						12	24	24	110	230	
Width 18 mm	<b>Valve with pilot interface to ISO 15218</b>										
		VSVA-B-T22...A2	2x 2/2-way valve, single solenoid	700	■	-	■	■	■	■	■
		VSVA-B-T32...A2	2x 3/2-way valve, single solenoid	600	■	-	■	■	■	■	■
		VSVA-B-M52...A2	5/2-way valve, single solenoid	750	■	-	■	■	■	■	■
		VSVA-B-B52...A2	5/2-way valve, double solenoid	750	■	-	■	■	■	■	■
		VSVA-B-P53...A2	5/3-way valve, mid-position valve	650	■	-	■	■	■	■	■
	<b>Valve with central plug</b>										
		VSVA-B-T32...A2	2x 3/2-way valve, single solenoid	600	■	-	-	■	-	-	-
		VSVA-B-M52...A2	5/2-way valve, single solenoid	750	■	-	-	■	-	-	-
		VSVA-B-B52...A2	5/2-way valve, double solenoid	750	■	-	-	■	-	-	-
		VSVA-B-P53...A2	5/3-way valve, mid-position valve	650	■	-	-	■	-	-	-
	<b>Pneumatic valve</b>										
		VSPA-B-T32...A2	2x 3/2-way valve, monostable	550	■	-	-	-	-	-	-
		VSPA-B-M52...A2	5/2-way valve, monostable	700	■	-	-	-	-	-	-
		VSPA-B-B52...A2	5/2-way valve, bistable	700	■	-	-	-	-	-	-
		VSPA-B-P53...A2	5/3-way valve, mid-position valve	650	■	-	-	-	-	-	-
Width 26 mm	<b>Valve with pilot interface to ISO 15218</b>										
		VSVA-B-T22...A1	2x 2/2-way valve, single solenoid	1350	-	■	■	■	■	■	■
		VSVA-B-T32...A1	2x 3/2-way valve, single solenoid	1250	-	■	■	■	■	■	■
		VSVA-B-M52...A1	5/2-way valve, single solenoid	1400	-	■	■	■	■	■	■
		VSVA-B-B52...A1	5/2-way valve, double solenoid	1400	-	■	■	■	■	■	■
		VSVA-B-P53...A1	5/3-way valve, mid-position valve	1400	-	■	■	■	■	■	■
	<b>Valve with pilot interface to ISO 15218, with position detection</b>										
		VSVA-B-M52...A1	5/2-way valve, single solenoid	1400	-	■	-	■	-	-	-
	<b>Valve with central plug</b>										
		VSVA-B-T32...A1	2x 3/2-way valve, single solenoid	1250	-	■	-	■	-	-	-
		VSVA-B-M52...A1	5/2-way valve, single solenoid	1400	-	■	-	■	-	-	-
		VSVA-B-B52...A1	5/2-way valve, double solenoid	1400	-	■	-	■	-	-	-
		VSVA-B-P53...A1	5/3-way valve, mid-position valve	1400	-	■	-	■	-	-	-
	<b>Pneumatic valve</b>										
		VSPA-B-T32...A1	2x 3/2-way valve, monostable	1250	-	■	-	-	-	-	-
		VSPA-B-M52...A1	5/2-way valve, monostable	1400	-	■	-	-	-	-	-
VSPA-B-B52...A1		5/2-way valve, bistable	1400	-	■	-	-	-	-	-	
VSPA-B-P53...A1		5/3-way valve, mid-position valve	1400	-	■	-	-	-	-	-	

# Solenoid/pneumatic valves, ISO 15407-1

Product range overview

Plug connector			Pilot air			→ Page/ Internet
Square	Round plug		In- ternal	Ex- ternal		
MEB	M8x1	M12x1				
<b>Valve with pilot interface to ISO 15218</b>						
■	-	■	■	■	Pneumatic spring return, normally closed	20
■	-	■	■	■	Pneumatic spring return, normally closed, open, 1x open/1x closed	20
■	-	■	■	■	Pneumatic or mechanical spring return	20
■	-	■	■	■	Dominance: 1st signal or at 14	20
■	-	■	■	■	Normally closed, exhausted, open	20
<b>Valve with central plug</b>						
-	■	■	■	■	Pneumatic spring return, normally closed, open, 1x open/1x closed	40
-	■	■	■	■	Pneumatic or mechanical spring return	40
-	■	■	■	■	Dominance: 1st signal or at 14	40
-	■	■	■	■	Normally closed, exhausted, open	40
<b>Pneumatic valve</b>						
-	■	■	■	■	Pneumatic spring return, normally closed, open, 1x open/1x closed	40
-	■	■	■	■	Pneumatic or mechanical spring return	40
-	■	■	■	■	Dominance: 1st signal or at 14	40
-	■	■	■	■	Normally closed, exhausted, open	40
<b>Valve with pilot interface to ISO 15218</b>						
■	-	■	■	■	Pneumatic spring return, normally closed	28
■	-	■	■	■	Pneumatic spring return, normally closed, open, 1x open/1x closed	28
■	-	■	■	■	Dominance: 1st signal or at 14	28
■	-	■	■	■	Normally closed, exhausted, open	28
■	-	■	■	■	Normally closed, exhausted, open	28
<b>Valve with pilot interface to ISO 15218, with position detection</b>						
■	-	-	-	■	Inductive sensor for monitoring normal position of piston spool valve	36
<b>Valve with central plug</b>						
-	■	■	■	■	Pneumatic spring return, normally closed, open, 1x open/1x closed	45
-	■	■	■	■	Dominance: 1st signal or at 14	45
-	■	■	■	■	Normally closed, exhausted, open	45
-	■	■	■	■	Normally closed, exhausted, open	45
<b>Pneumatic valve</b>						
-	■	■	■	■	Pneumatic spring return, normally closed, open, 1x open/1x closed	45
-	■	■	■	■	Dominance: 1st signal or at 14	45
-	■	■	■	■	Normally closed, exhausted, open	45
-	■	■	■	■	Normally closed, exhausted, open	45

# Solenoid valves VSVA, ISO 15407-1

Type codes

VSVA		-	B	-	T	32	C	-	A	Z	H
<b>Valve series</b>											
VSVA	Standard valves to ISO 15407-1/-2										
<b>Valve type</b>											
B	Sub-base valve										
<b>Valve function</b>											
M	Single solenoid										
B	Double solenoid										
D	Double solenoid with dominant signal at 14										
P	Single solenoid, mid-position										
T	2 single solenoid valves in one housing										
<b>Connections/switching positions</b>											
22	2/2-way valve										
32	3/2-way valve										
52	5/2-way valve										
53	5/3-way valve										
<b>Normal position</b>											
C	Closed										
N	Code T with 2x closed, reverse operation										
U	Open										
F	Code T with 2x open, reverse operation										
E	Exhausted										
H	Code T with 1x open, 1x closed										
W	Code T with 1x open, 1x closed, reverse operation										
-	Double solenoid valve										
<b>Type of reset</b>											
A	Pneumatic spring										
M	Mechanical spring										
-	Double solenoid valve										
<b>Pilot air supply port</b>											
Z	External										
-	Internal										
<b>Manual override</b>											
H	With manual override										
-	Without manual override										

# Solenoid valves VSVA, to ISO 15407-1

Type code

→	-	A1	-	1	C1	-	
<b>Standard</b>							
A1	ISO size 01, width 26 mm						
A2	ISO size 02, width 18 mm						
<b>Operating voltage</b>							
1	24 V DC						
1A	24 V AC						
2A	110 V AC						
3A	230 V AC						
5	12 V DC						
-	Without pilot valve						
<b>Electrical connection</b>							
C1	Type C to EN 175301-803						
R2	Central plug M8x1						
R3	Individual plug M12						
R5	Central plug M12x1						
P1	Without pilot valve						
<b>Signal status display</b>							
L	LED (integrated)						
-	Without signal status display						
<b>Position detection</b>							
APC	Proximity sensor PNP With open cable end						
APP	Proximity sensor PNP With plug M8						
ANC	Proximity sensor NPN With open cable end						
ANP	Proximity sensor NPN With plug M8						
-	Without sensor						

# Pneumatic valves VSPA, ISO 15407-1

Type codes

VSPA - B - M 52 - A - A1

Valve series	
VSPA	Standard valves to ISO 15407-1/-2
Valve type	
B	Sub-base valve
Valve function	
M	Monostable
B	Bistable
D	Bistable with dominant signal at 14
P	Monostable, mid-position
T	2 monostable valves in one housing
Connections/switching positions	
32	3/2-way valve
52	5/2-way valve
53	5/3-way valve
Normal position	
C	Closed
U	Open
E	Exhausted
H	Code T with 1x open, 1x closed
-	Bistable valve
Type of reset	
A	Pneumatic spring
M	Mechanical spring
-	Bistable valve
Standard	
A1	ISO size 01, width 26 mm
A2	ISO size 02, width 18 mm

# Solenoid/pneumatic valves, ISO 15407-1

Peripherals overview

FESTO

## Individual mounting

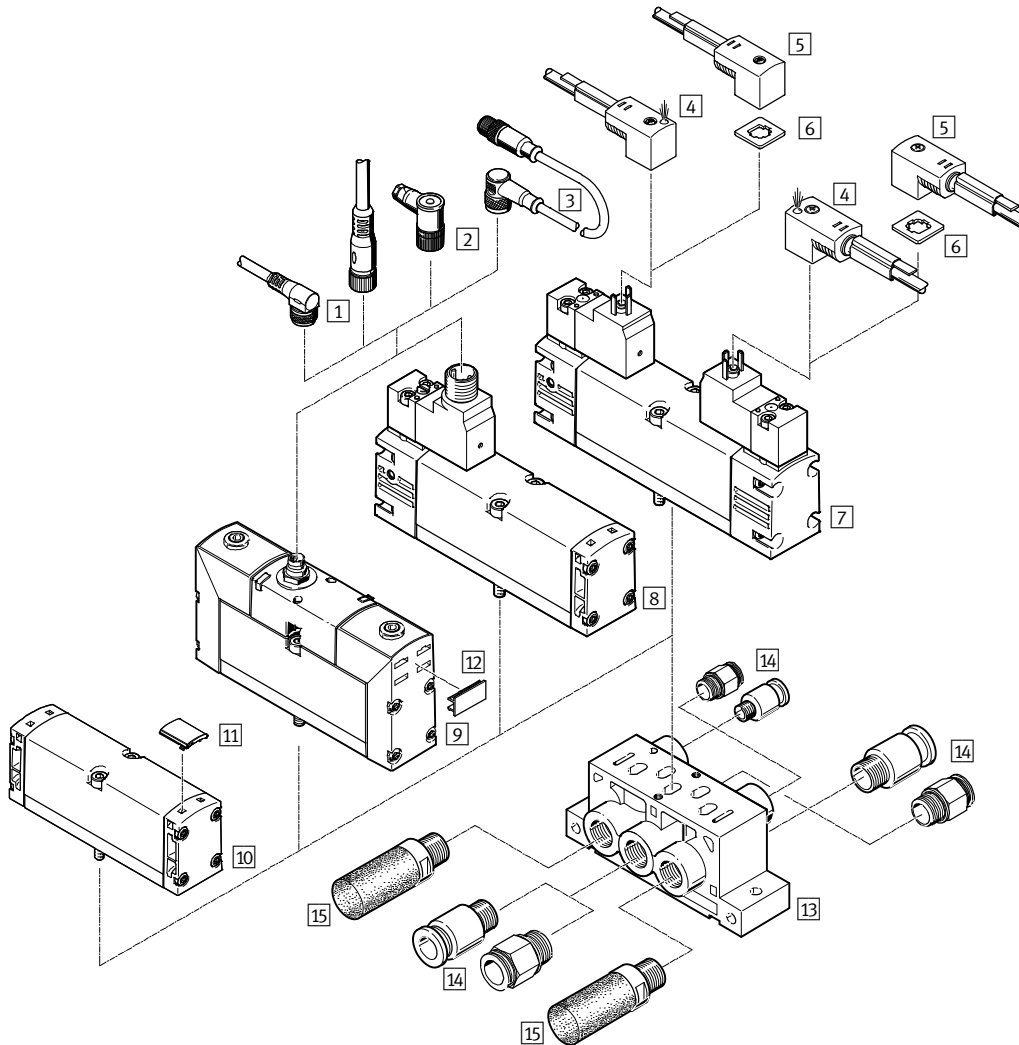

	Type	Brief description	→ Page/Internet	
1	Connecting cable	NEBU	For valves with round plug	74
2	Plug socket	SEA-M12-4WD	Angled	74
3	Connecting cable	KM-12-M12	Angled socket, straight plug, for valves with round plug M12x1	74
4	Connecting cable	KMEB...-LED	With PVC casing and LED	74
5	Connecting cable	KMEB	With PVC casing	74
6	Illuminating seal	MEB-LD	For indicating the signal status	74
7	Solenoid valve	VSVA-...C	With interface to ISO 15218 and plug pattern type C	20
8	Solenoid valve	VSVA-...R3	With interface to ISO 15218 and round plug	20
9	Solenoid valve	VSVA-...R	With round plug	40
10	Pneumatic valve	VSPA	Port pattern to ISO 15407-1	50
11	Inscription label holder	ASCF	For identifying the VSPA pneumatic valves	73
12	Inscription labels	IBS-9x20	For identifying the VSVA valves with round plug	73
13	Individual sub-base	NAS	With lateral ports	61
14	Push-in fitting	QS	For standard O.D. tubing	73
15	Silencer	U	For fitting in exhaust ports	73

# Solenoid valves, ISO 15407-1

Peripherals overview

FESTO

## Manifold assembly – Solenoid valves

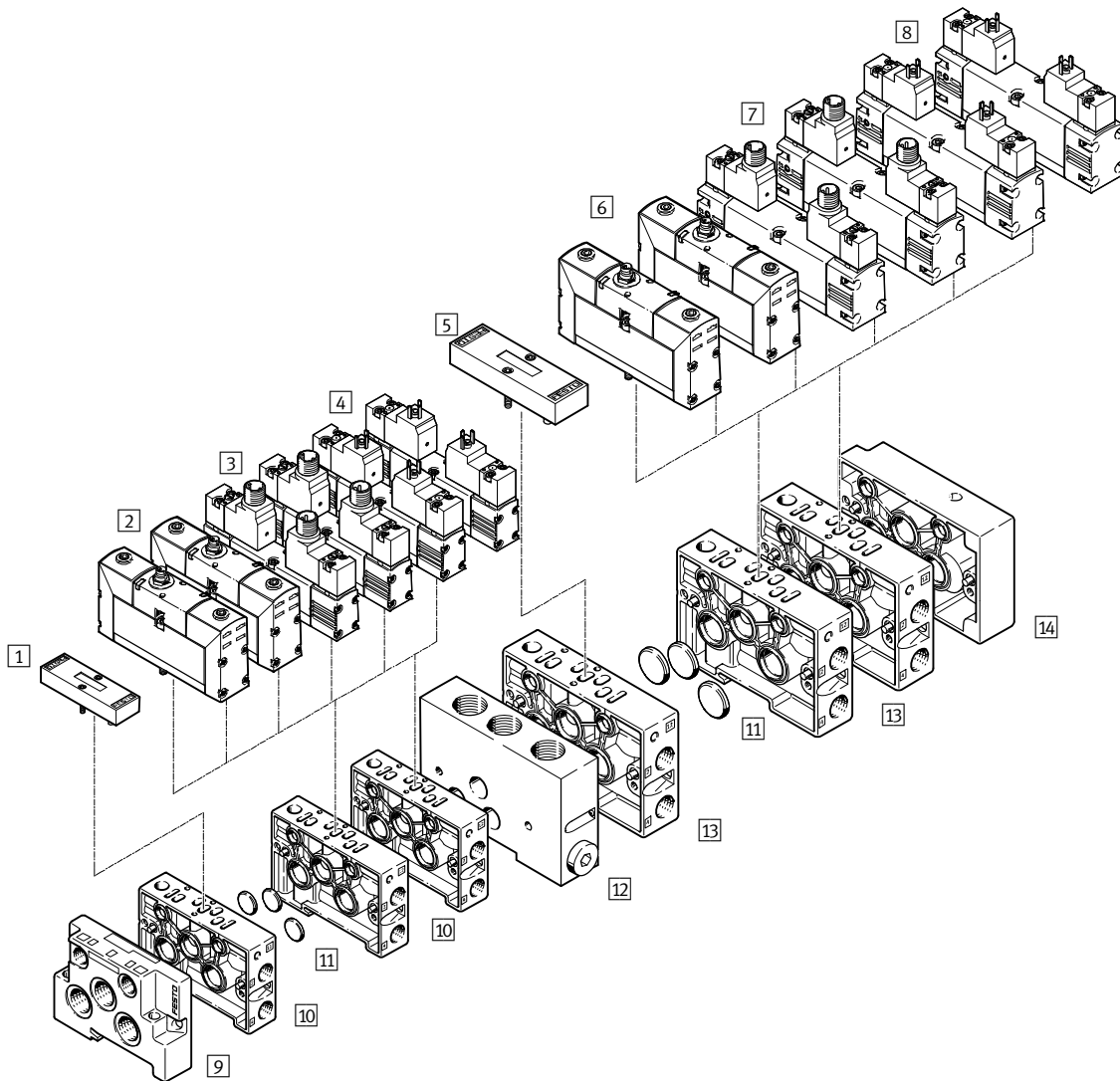

	Type	Brief description	→ Page/Internet	
1	Blanking plate	NDV-02-VDMA	For width 18 mm, vacant or spare position	71
2	Solenoid valve	VSVA...A2...R	Width 18 mm with round plug	40
3	Solenoid valve	VSVA...A2...R3	Width 18 mm, interface to ISO 15218 with round plug	20
4	Solenoid valve	VSVA...A2...C	Width 18 mm, interface to ISO 15218 with plug pattern type C	20
5	Blanking plate	NDV-01-VDMA	For width 26 mm, vacant or spare position	71
6	Solenoid valve	VSVA...A1...R	Width 26 mm with round plug	45
7	Solenoid valve	VSVA...A1...R3	Width 26 mm, interface to ISO 15218 with round plug	28
8	Solenoid valve	VSVA...A1...C	Width 26 mm, interface to ISO 15218 with plug pattern type C	28
9	End plate	NEV	For sealing the manifold sub-bases width 18 mm	62
10	Manifold sub-base	NAW-1/8-02-VDMA	Width 18 mm with lateral ports 2 and 4	62
11	Isolating disc	NSC	For creating pressure zones or for sealing ports on the end plates	71
12	Intermediate plate	NZV-01/02-VDMA	For connecting width 18 mm with width 26 mm	63
13	Manifold sub-base	NAW-1/4-01-VDMA	Width 26 mm with lateral ports 2 and 4	62
14	End plate	NEV	For sealing the manifold sub-bases width 26 mm	62



# Pneumatic valves VSPA, ISO 15407-1

Peripherals overview

## Manifold assembly – Pneumatic valves

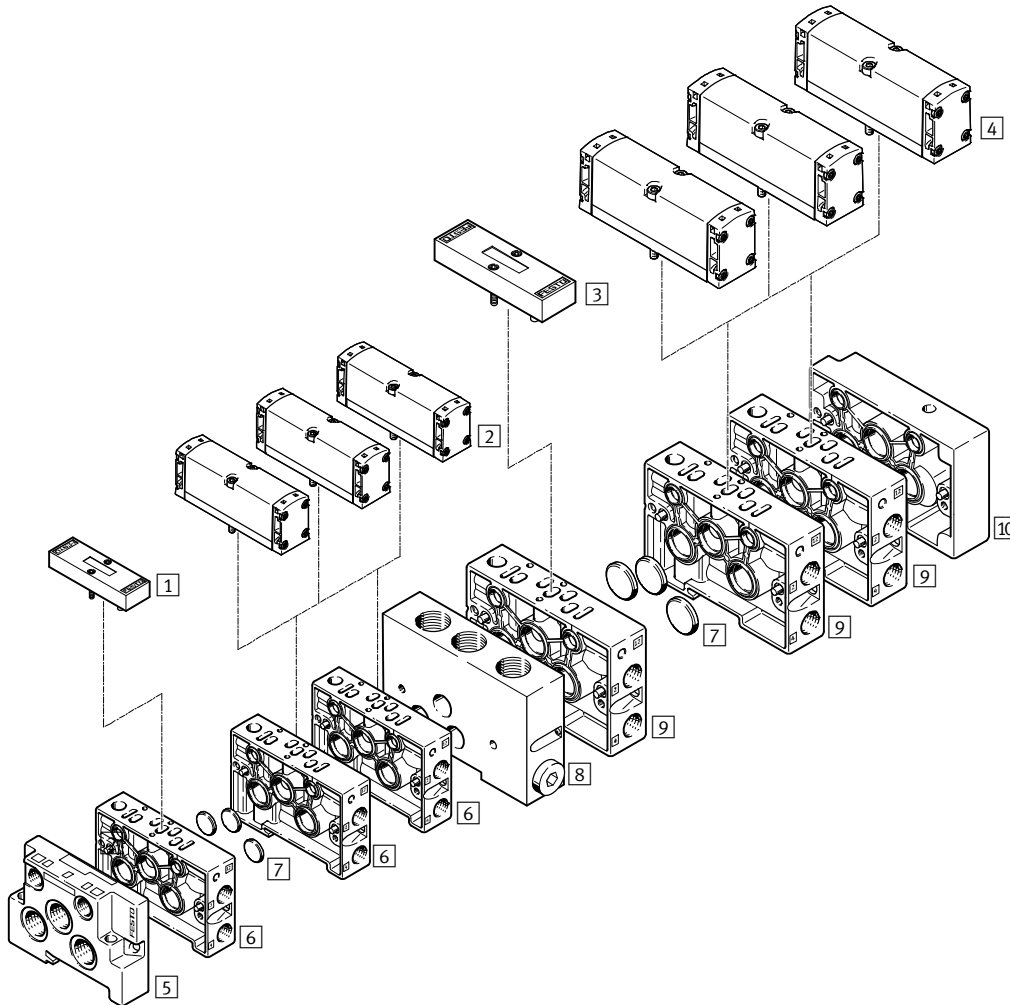

	Type	Brief description	→ Page/Internet
1	NDV-02-VDMA	For width 18, vacant or spare position	71
2	VSPA...A2	Width 18	50
3	NDV-01-VDMA	For width 26, vacant or spare position	71
4	VSPA...A1	Width 26	53
5	NEV	For sealing the manifold sub-bases width 18	62
6	NAW-1/8-02-VDMA	Width 18 with lateral ports 2 and 4	62
7	NSC	For creating pressure zones or for sealing ports on the end plates	71
8	NZV-01/02-VDMA	For connecting width 18 with width 26	63
9	NAW-1/4-01-VDMA	Width 26 with lateral ports 2 and 4	62
10	NEV	For sealing the manifold sub-bases width 26	62

# Solenoid valves VSVA, ISO 15407-1

Peripherals overview

FESTO

## Manifold assembly with vertical stacking

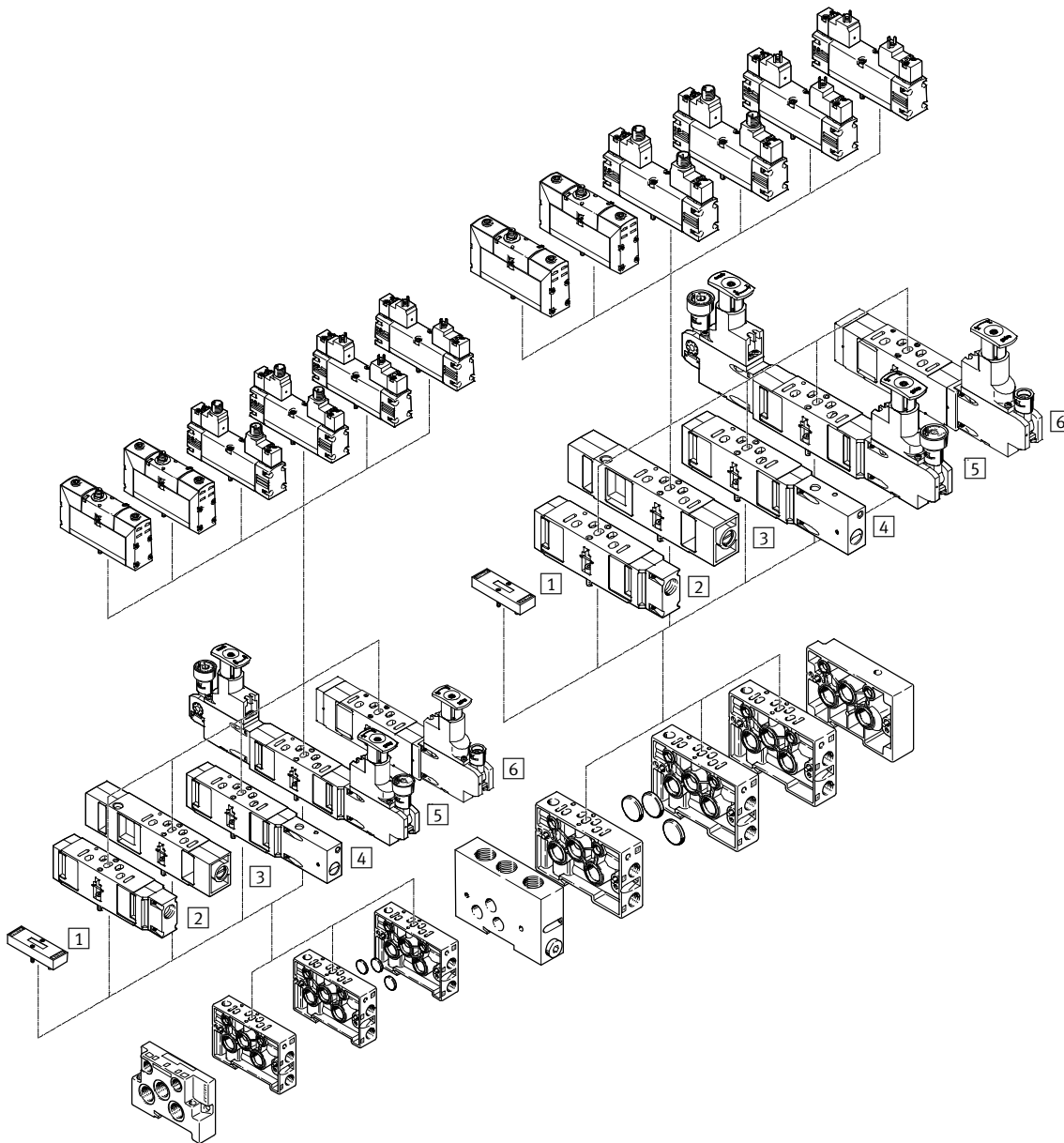

	Type	Brief description	→ Page/Internet
1	NDV	For vacant or spare position	71
2	VABF...P1-A3	For intermediate air supply	59
3	VABF...F1-B1	For flow control in ducts 3 and 5	58
4	VABF...L1-D1	With switch for manual shut-off of duct 1	60
5	VABF...R...-C2	With 2 pressure regulators for working ports 2 and 4	56
6	VABF...R...-C2	With one pressure regulator for working ports 2 or 4 or for duct 1	56

# Solenoid valves VSVA, ISO 15407-1

Peripherals overview

## Manifold assembly

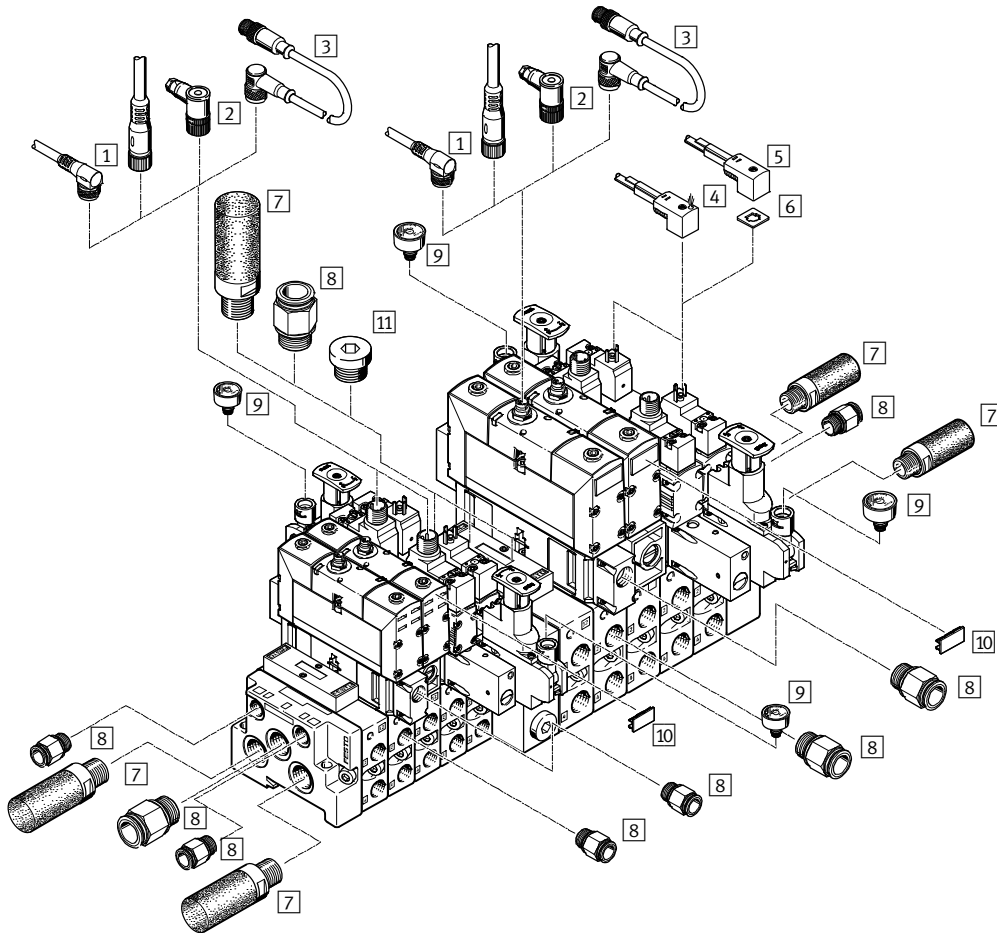



	Type	Brief description	→ Page/Internet	
1	Connecting cable	NEBU	For valves with round plug	74
2	Plug socket	SEA-M12-4WD	Angled	74
3	Connecting cable	KM-12-M12	Angled socket, straight plug, for valves with round plug M12x1	74
4	Connecting cable	KMEB...-LED	With PVC casing and LED	74
5	Connecting cable	KMEB	With PVC casing	74
6	Illuminating seal	MEB-LD	For indicating the signal status	74
7	Silencer	U	For fitting in exhaust ports	73
8	Push-in fitting	QS	For standard O.D. tubing	73
9	Pressure gauge	PAGN-26-10-P10	Can be connected to the pressure regulator plate	73
10	Inscription labels	IBS-9x20	For identifying the VSVA valves with round plug	73
11	Blanking plug	B	For sealing unused ports	73

# Solenoid valves VSVA, with pilot interface to ISO 15218

FESTO

Technical data – Width 18 mm

-  - Flow rate  
Max. 750 l/min

-  - Voltage  
12, 24 V DC  
24, 110, 230 V AC

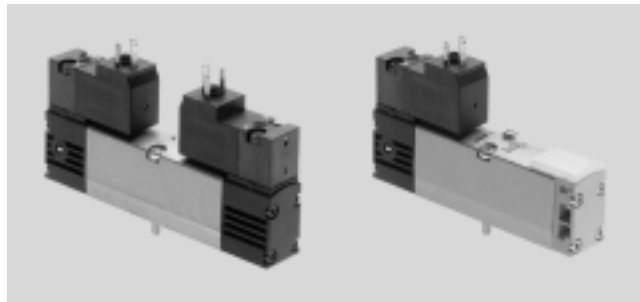

General technical data					
Valve function	2x 2/2-way	2x 3/2-way	5/2-way		5/3-way
Normal position	C <sup>1)</sup>	C <sup>1)</sup> , U <sup>2)</sup> , H <sup>4)</sup> , N <sup>5)</sup> , F <sup>6)</sup> , W <sup>7)</sup>	–	–	C <sup>1)</sup> , U <sup>2)</sup> , E <sup>3)</sup>
Stable position	Monostable	Monostable	Monostable	Bistable	Monostable
Reset method: pneumatic spring	Yes	Yes	Yes	–	No
Reset method: mechanical spring	No	No	Yes	–	Yes
Design	Piston spool				
Sealing principle	Soft				
Type of actuation	Electrical				
Type of pilot control	Piloted				
Pilot interface	To ISO 15218				
Pilot air supply	Internal or external				
Pilot air supply, exhaust air	Not ducted according to standard or ducted				
Direction of flow	Non-reversible or reversible	Non-reversible or reversible only	Reversible with external pilot air supply		
Exhaust air function	With flow control				
Manual override	Non-detenting, non-detenting/detenting				
Type of mounting	On sub-base				
Mounting position	Any				
Nominal width [mm]	5				
Flow rate of valve [l/min]	700	600	750	650	
Flow rate of valve on individual sub-base [l/min]	450	450	550	500	
Flow rate of pneumatically interlinked valve [l/min]	500	400	550	450	
Standard nominal flow rate [l/min]	500	400	550	450	
Switching time on/off, pneumatic spring [ms]	13/21	13/21	21/19	–	–
Switching time on/off, mechanical spring [ms]	–	–	17/35	–	18/30
Switching time on/off, for N, F and W [ms]	–	21/13	–	–	–
Changeover time [ms]	–	–	–	15	20
Non-overlapping	Yes				
Valve size [mm]	18				
Ports on the sub-base	1, 2, 3, 4, 5	G1/8			
	12, 14	M5			
Tightening torque for valve mounting [Nm]	0.9 ... 1.1				
Product weight	Without pilot valve [g]	98	98	89	98
	Solenoid valve [g]	174	174	127	174
Noise level [dB (A)]	85				
Conforms to standard	ISO 15407-1, VDMA 24563 and for pilot valve interface ISO 15218				

- 1) C=Normally closed
- 2) U = Normally open
- 3) E = Normally exhausted
- 4) H=2x 3/2-way valve in one housing with 1x normally closed and 1x normally open
- 5) N=Normally closed, reverse operation, i.e. the pressure supply ports are 3 and 5, venting is via port 1
- 6) F=Normally open, reverse operation, i.e. the pressure supply ports are 3 and 5, venting is via port 1
- 7) W=2x 3/2-way valve in one housing with 1x normally closed and 1x normally open, reverse operation, i.e. the pressure supply ports are 3 and 5, venting is via port 1

# Solenoid valves VSVA, with pilot interface to ISO 15218

Technical data – Width 18 mm

Safety data			
Type	VSVA-...-1C1	VSVA-...-P1 VSVA-...-5C1 VSVA-...-1AC1	VSVA-...-2AC1 VSVA-...-3AC1
Note on forced switch on/off	Switching frequency min. 1/week		
CE marking (see declaration of conformity)	–		To EU Low Voltage Directive
Max. positive test pulse with 0 signal	[μs]	1000	–
Max. negative test pulse with 1 signal	[μs]	800	–
Shock resistance	Shock test with severity level 2 to FN 942017-5 and EN 60068-2-27		
Vibration resistance	Transport application test with severity level 2 to FN 942017-4 and EN 60068-2-6		

Operating and environmental conditions						
Valve function		2x2/2-way	2x3/2-way	5/2-way	5/3-way	
Operating medium	Compressed air to ISO 8573-1:2010 [7:4:4]					
Pilot medium	Compressed air to ISO 8573-1:2010 [7:4:4]					
Note on operating/pilot medium	Lubricated operation possible (in which case lubricated operation will always be required)					
Operating pressure	Internal pilot air supply	[bar]	2 ... 10	2 ... 10	2 ... 10, 3 ... 10 with mechanical spring	3 ... 10
	External pilot air supply	[bar]	2 ... 10	2 ... 10	–0.9 ... 10	
Pilot pressure with pneumatic spring	[bar]	3 ... 10 <sup>1)</sup>	3 ... 10 <sup>1)</sup>	3 ... 10	–	
Pilot pressure with mechanical spring	[bar]	–	–	3 ... 10	3 ... 10	
Ambient temperature	[°C]	–5 ... +50				
Temperature of medium	[°C]	–5 ... +50				

1) Pilot pressure dependent on operating pressure → Graph

## Minimum pilot pressure p12, p14 as a function of operating pressure p1 (external pilot air supply)

2x 3/2-way solenoid valve

5/2-way solenoid valve and 5/3-way solenoid valve

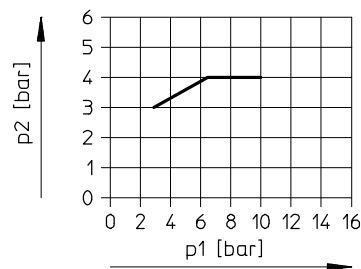
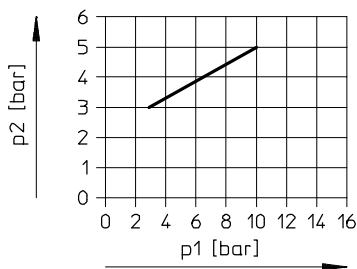

Electrical data			
Electrical connection	Plug, square design to EN 175301-803, type C, 110 V/230 V AC with protective earth conductor		M12 plug, round design
Operating voltage	DC voltage	[V DC]	12, 24 +10%/-15%
	Alternating voltage	[V AC]	24, 110, 230 +10%/-15%
Characteristic coil data	DC voltage	[W]	1.8
	AC voltage	[VA]	At 24 V AC: • 3.1 pickup power • 2.3 holding power At 110 V AC and 230 V AC: • 2.9 pickup power • 2.1 holding power
Duty cycle	[%]	100	
Degree of protection to EN 60529	IP65, Nema 4 (in combination with plug socket)		

# Solenoid valves VSVA, with pilot interface to ISO 15218

Technical data – Width 18 mm



## Materials

Sectional view

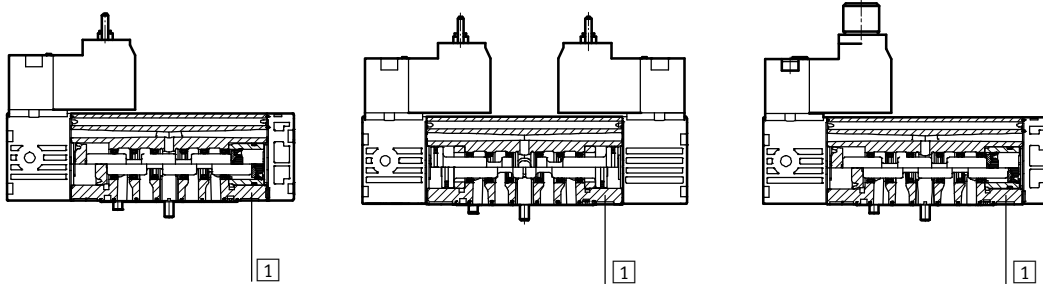

1	Housing	Die-cast aluminium
-	Seals	HNBR, NBR
-	Screws	Galvanised steel
-	Note on materials	RoHS compliant

## Dimensions

Download CAD data → [www.festo.com](http://www.festo.com)

5/2-way valve, single solenoid with plug type C, VSVA-B-M52...C1

5/2-way valve, single solenoid with M12 plug, VSVA-B-M52...R3

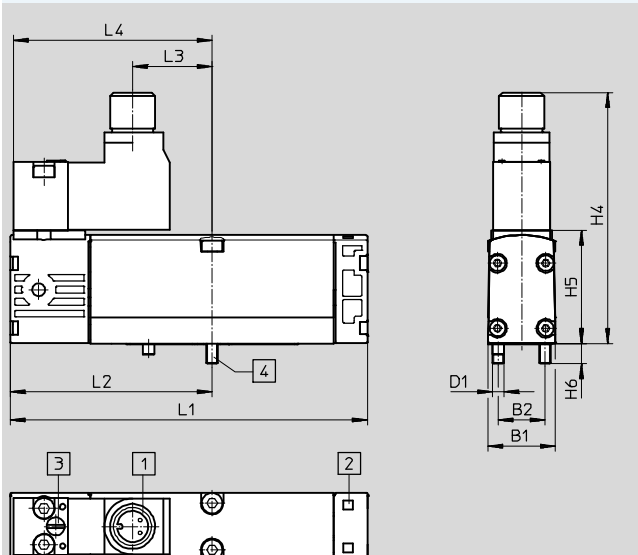
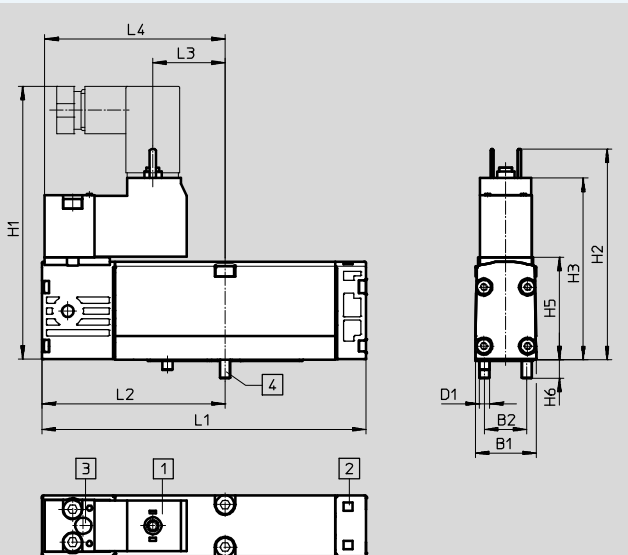

- 1 Connection dimensions and device plug to EN 175301-803, type C
- 2 Slot for inscription label
- 3 Manual override
- 4 Captive screws

- 1 Connection dimensions and device plug, M12 plug
- 2 Slot for inscription label
- 3 Manual override
- 4 Captive screws

	B1	B2	D1	H1	H2	H3	H4	H5	H6	L1	L2	L3	L4
VSVA-B-M52...C1	18	12.5	M3	80.6	62.2	53.6	–	30.3	5.4	95.4	53.9	21.3	53.1
VSVA-B-M52...R3	18	12.5	M3	–	–	–	67	30.3	5.4	95.4	53.9	21.3	53.1

# Solenoid valves VSVA, with pilot interface to ISO 15218

Technical data – Width 18 mm

## Dimensions

Download CAD data → [www.festo.com](http://www.festo.com)

2x 2/2-way valve, 2x 3/2-way valve, 5/2-way valve, double solenoid, 5/3-way valve

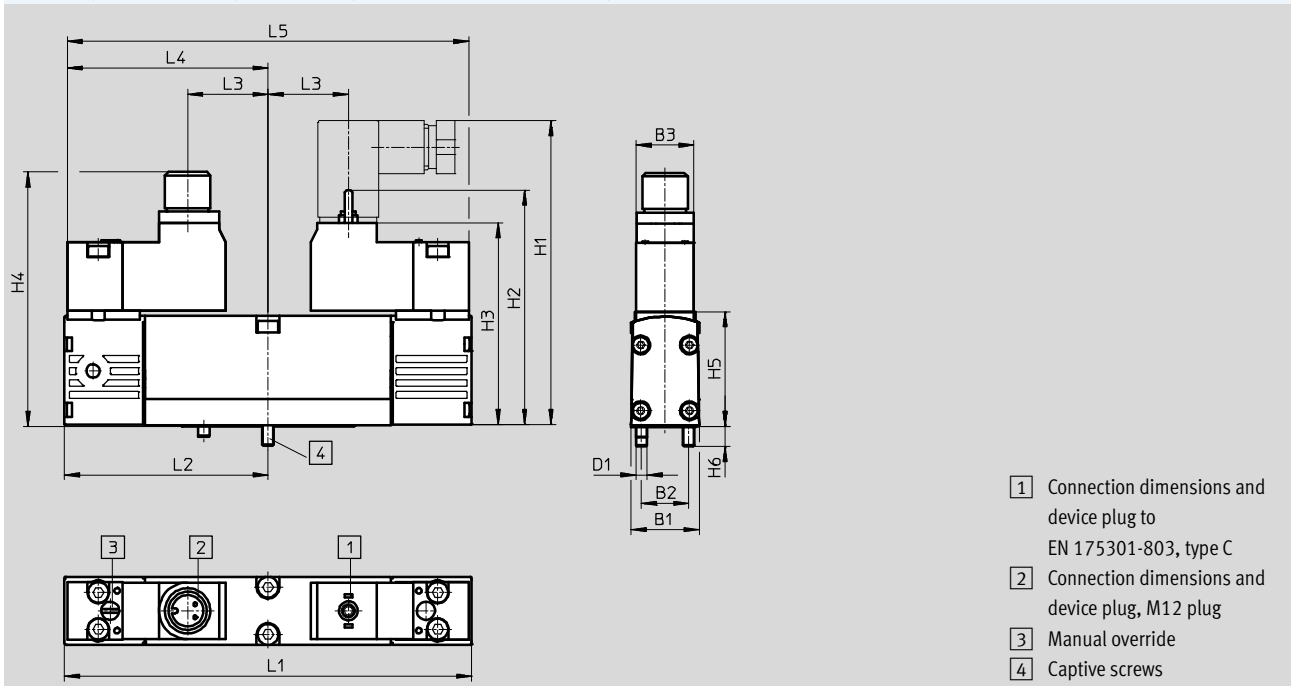

	B1	B2	B3	D1	H1	H2	H3	H4	H5	H6	L1	L2	L3	L4	L5
VSVA-B-T22C	18	12.5	15.2	M3	80.6	62.2	53.6	67	30.3	5.4	107.8	53.9	21.3	53.1	102.2
VSVA-B-T32															
VSVA-B-B52															
VSVA-B-D52															
VSVA-B-P53															

## Dimensions

Download CAD data → [www.festo.com](http://www.festo.com)

Pilot valve with plug type C, VSCS-...C1

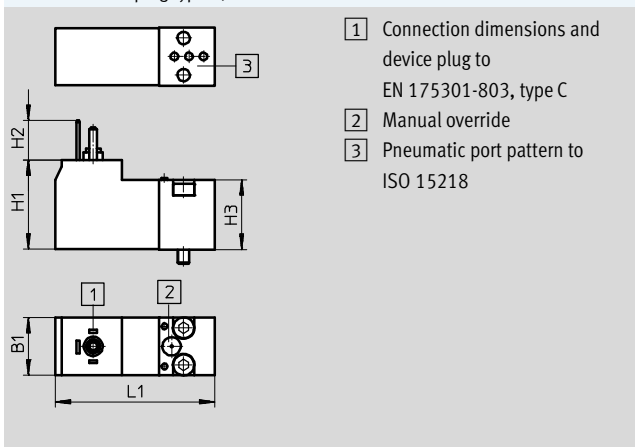

Pilot valve with M12 plug, VSCS-...R3

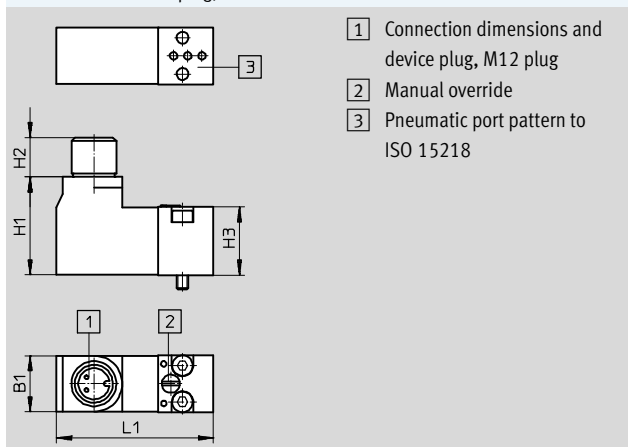

	B1	H1	H2	H3	L1
VSCS-...C1	15.2	23.2	10.5	18.2	41.9
VSCS-...R3	15	26.1	10.6	18.2	41.9

# Solenoid valves VSVA, with pilot interface to ISO 15218

Technical data – Width 18 mm

**FESTO**

Ordering data – Pilot control assembled						
Code	Circuit symbol		Part No.	Type		
2x 2/2-way solenoid valve						
T22C	–	Order via online configurator	–	–		
2x 3/2-way solenoid valve, with pilot control with square plug, type C to EN 175301-803						
K		Normal position: 2x closed	Internal pilot air supply	24 V DC	<b>546693</b>	<b>VSVA-B-T32C-AH-A2-1C1</b>
				12 V DC	<b>547129</b>	<b>VSVA-B-T32C-AH-A2-5C1</b>
				230 V AC	<b>547209</b>	<b>VSVA-B-T32C-AH-A2-3AC1</b>
				110 V AC	<b>547169</b>	<b>VSVA-B-T32C-AH-A2-2AC1</b>
				24 V AC	<b>547089</b>	<b>VSVA-B-T32C-AH-A2-1AC1</b>
N		Normal position: 2x open	Internal pilot air supply	24 V DC	<b>546695</b>	<b>VSVA-B-T32U-AH-A2-1C1</b>
				12 V DC	<b>547131</b>	<b>VSVA-B-T32U-AH-A2-5C1</b>
				230 V AC	<b>547211</b>	<b>VSVA-B-T32U-AH-A2-3AC1</b>
				110 V AC	<b>547171</b>	<b>VSVA-B-T32U-AH-A2-2AC1</b>
				24 V AC	<b>547091</b>	<b>VSVA-B-T32U-AH-A2-1AC1</b>
H		Normal position: 1x closed 1x open	Internal pilot air supply	24 V DC	<b>547067</b>	<b>VSVA-B-T32H-AH-A2-1C1</b>
				12 V DC	<b>547133</b>	<b>VSVA-B-T32H-AH-A2-5C1</b>
				230 V AC	<b>547213</b>	<b>VSVA-B-T32H-AH-A2-3AC1</b>
				110 V AC	<b>547173</b>	<b>VSVA-B-T32H-AH-A2-2AC1</b>
				24 V AC	<b>547093</b>	<b>VSVA-B-T32H-AH-A2-1AC1</b>
K		Normal position: 2x closed	External pilot air supply	24 V DC	<b>547069</b>	<b>VSVA-B-T32C-AZH-A2-1C1</b>
				12 V DC	<b>547149</b>	<b>VSVA-B-T32C-AZH-A2-5C1</b>
				230 V AC	<b>547229</b>	<b>VSVA-B-T32C-AZH-A2-3AC1</b>
				110 V AC	<b>547189</b>	<b>VSVA-B-T32C-AZH-A2-2AC1</b>
				24 V AC	<b>547109</b>	<b>VSVA-B-T32C-AZH-A2-1AC1</b>
N		Normal position: 2x open	External pilot air supply	24 V DC	<b>547071</b>	<b>VSVA-B-T32U-AZH-A2-1C1</b>
				12 V DC	<b>547151</b>	<b>VSVA-B-T32U-AZH-A2-5C1</b>
				230 V AC	<b>547231</b>	<b>VSVA-B-T32U-AZH-A2-3AC1</b>
				110 V AC	<b>547191</b>	<b>VSVA-B-T32U-AZH-A2-2AC1</b>
				24 V AC	<b>547111</b>	<b>VSVA-B-T32U-AZH-A2-1AC1</b>
H		Normal position: 1x closed 1x open	External pilot air supply	24 V DC	<b>547073</b>	<b>VSVA-B-T32H-AZH-A2-1C1</b>
				12 V DC	<b>547153</b>	<b>VSVA-B-T32H-AZH-A2-5C1</b>
				230 V AC	<b>547233</b>	<b>VSVA-B-T32H-AZH-A2-3AC1</b>
				110 V AC	<b>547193</b>	<b>VSVA-B-T32H-AZH-A2-2AC1</b>
				24 V AC	<b>547113</b>	<b>VSVA-B-T32H-AZH-A2-1AC1</b>



# Solenoid valves VSVA, with pilot interface to ISO 15218

Technical data – Width 18 mm

Ordering data – Pilot control assembled						
Code	Circuit symbol			Part No.	Type	
5/2-way valve, single solenoid, with pilot control with square plug, type C to EN 175301-803						
M		Pneumatic spring	Internal pilot air supply	24 V DC	546701	VSVA-B-M52-AH-A2-1C1
				12 V DC	547139	VSVA-B-M52-AH-A2-5C1
				230 V AC	547219	VSVA-B-M52-AH-A2-3AC1
				110 V AC	547179	VSVA-B-M52-AH-A2-2AC1
				24 V AC	547099	VSVA-B-M52-AH-A2-1AC1
O		Mechanical spring	Internal pilot air supply	24 V DC	546703	VSVA-B-M52-MH-A2-1C1
				12 V DC	547141	VSVA-B-M52-MH-A2-5C1
				230 V AC	547221	VSVA-B-M52-MH-A2-3AC1
				110 V AC	547181	VSVA-B-M52-MH-A2-2AC1
				24 V AC	547101	VSVA-B-M52-MH-A2-1AC1
M		Pneumatic spring	External pilot air supply	24 V DC	547079	VSVA-B-M52-AZH-A2-1C1
				12 V DC	547159	VSVA-B-M52-AZH-A2-5C1
				230 V AC	547239	VSVA-B-M52-AZH-A2-3AC1
				110 V AC	547199	VSVA-B-M52-AZH-A2-2AC1
				24 V AC	547119	VSVA-B-M52-AZH-A2-1AC1
O		Mechanical spring	External pilot air supply	24 V DC	547081	VSVA-B-M52-MZH-A2-1C1
				12 V DC	547161	VSVA-B-M52-MZH-A2-5C1
				230 V AC	547241	VSVA-B-M52-MZH-A2-3AC1
				110 V AC	547201	VSVA-B-M52-MZH-A2-2AC1
				24 V AC	547121	VSVA-B-M52-MZH-A2-1AC1
5/2-way valve, double solenoid, with pilot control with square plug, type C to EN 175301-803						
J		Dominant 1st signal	Internal pilot air supply	24 V DC	546697	VSVA-B-B52-H-A2-1C1
				12 V DC	547135	VSVA-B-B52-H-A2-5C1
				230 V AC	547215	VSVA-B-B52-H-A2-3AC1
				110 V AC	547175	VSVA-B-B52-H-A2-2AC1
				24 V AC	547095	VSVA-B-B52-H-A2-1AC1
D		Dominant at 14	Internal pilot air supply	24 V DC	546699	VSVA-B-D52-H-A2-1C1
				12 V DC	547137	VSVA-B-D52-H-A2-5C1
				230 V AC	547217	VSVA-B-D52-H-A2-3AC1
				110 V AC	547177	VSVA-B-D52-H-A2-2AC1
				24 V AC	547097	VSVA-B-D52-H-A2-1AC1
J		Dominant 1st signal	External pilot air supply	24 V DC	547075	VSVA-B-B52-ZH-A2-1C1
				12 V DC	547155	VSVA-B-B52-ZH-A2-5C1
				230 V AC	547235	VSVA-B-B52-ZH-A2-3AC1
				110 V AC	547195	VSVA-B-B52-ZH-A2-2AC1
				24 V AC	547115	VSVA-B-B52-ZH-A2-1AC1
D		Dominant at 14	External pilot air supply	24 V DC	547077	VSVA-B-D52-ZH-A2-1C1
				12 V DC	547157	VSVA-B-D52-ZH-A2-5C1
				230 V AC	547237	VSVA-B-D52-ZH-A2-3AC1
				110 V AC	547197	VSVA-B-D52-ZH-A2-2AC1
				24 V AC	547117	VSVA-B-D52-ZH-A2-1AC1





# Solenoid valves VSVA, with pilot interface to ISO 15218

Technical data – Width 18 mm

Ordering data – Pilot control assembled						
Code	Circuit symbol			Part No.	Type	
5/3-way solenoid valve, with pilot control with square plug, type C to EN 175301-803						
G		Normal position: closed	Internal pilot air supply	24 V DC	<b>546709</b>	<b>VSVA-B-P53C-H-A2-1C1</b>
				12 V DC	<b>547147</b>	<b>VSVA-B-P53C-H-A2-5C1</b>
				230 V AC	<b>547227</b>	<b>VSVA-B-P53C-H-A2-3AC1</b>
				110 V AC	<b>547187</b>	<b>VSVA-B-P53C-H-A2-2AC1</b>
				24 V AC	<b>547107</b>	<b>VSVA-B-P53C-H-A2-1AC1</b>
B		Normal position: open	Internal pilot air supply	24 V DC	<b>546705</b>	<b>VSVA-B-P53U-H-A2-1C1</b>
				12 V DC	<b>547143</b>	<b>VSVA-B-P53U-H-A2-5C1</b>
				230 V AC	<b>547223</b>	<b>VSVA-B-P53U-H-A2-3AC1</b>
				110 V AC	<b>547183</b>	<b>VSVA-B-P53U-H-A2-2AC1</b>
				24 V AC	<b>547103</b>	<b>VSVA-B-P53U-H-A2-1AC1</b>
E		Normal position: exhausted	Internal pilot air supply	24 V DC	<b>546707</b>	<b>VSVA-B-P53E-H-A2-1C1</b>
				12 V DC	<b>547145</b>	<b>VSVA-B-P53E-H-A2-5C1</b>
				230 V AC	<b>547225</b>	<b>VSVA-B-P53E-H-A2-3AC1</b>
				110 V AC	<b>547185</b>	<b>VSVA-B-P53E-H-A2-2AC1</b>
				24 V AC	<b>547105</b>	<b>VSVA-B-P53E-H-A2-1AC1</b>
G		Normal position: closed	External pilot air supply	24 V DC	<b>547087</b>	<b>VSVA-B-P53C-ZH-A2-1C1</b>
				12 V DC	<b>547167</b>	<b>VSVA-B-P53C-ZH-A2-5C1</b>
				230 V AC	<b>547247</b>	<b>VSVA-B-P53C-ZH-A2-3AC1</b>
				110 V AC	<b>547207</b>	<b>VSVA-B-P53C-ZH-A2-2AC1</b>
				24 V AC	<b>547127</b>	<b>VSVA-B-P53C-ZH-A2-1AC1</b>
B		Normal position: open	External pilot air supply	24 V DC	<b>547083</b>	<b>VSVA-B-P53U-ZH-A2-1C1</b>
				12 V DC	<b>547163</b>	<b>VSVA-B-P53U-ZH-A2-5C1</b>
				230 V AC	<b>547243</b>	<b>VSVA-B-P53U-ZH-A2-3AC1</b>
				110 V AC	<b>547203</b>	<b>VSVA-B-P53U-ZH-A2-2AC1</b>
				24 V AC	<b>547123</b>	<b>VSVA-B-P53U-ZH-A2-1AC1</b>
E		Normal position: exhausted	External pilot air supply	24 V DC	<b>547085</b>	<b>VSVA-B-P53E-ZH-A2-1C1</b>
				12 V DC	<b>547165</b>	<b>VSVA-B-P53E-ZH-A2-5C1</b>
				230 V AC	<b>547245</b>	<b>VSVA-B-P53E-ZH-A2-3AC1</b>
				110 V AC	<b>547205</b>	<b>VSVA-B-P53E-ZH-A2-2AC1</b>
				24 V AC	<b>547125</b>	<b>VSVA-B-P53E-ZH-A2-1AC1</b>

# Solenoid valves VSVA, with pilot interface to ISO 15218

Technical data – Width 18 mm

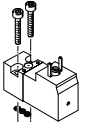
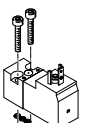
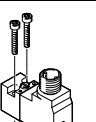
Ordering data – Pilot control separate					
				Part No.	Type
<b>2x 3/2-way valve without pilot valves</b>					
	Internal pilot air supply	2x normally closed	546732	VSVA-B-T32C-A-A2-P1	
		2x normally open	546734	VSVA-B-T32U-A-A2-P1	
<b>5/2-way valve, single solenoid, without pilot valve</b>					
	Internal pilot air supply	Pneumatic spring	546740	VSVA-B-M52-A-A2-P1	
		Mechanical spring	546742	VSVA-B-M52-M-A2-P1	
<b>5/2-way valve, double solenoid, without pilot valve</b>					
	Internal pilot air supply	Dominant 1st signal	546736	VSVA-B-B52-A2-P1	
		Dominant at 14	546738	VSVA-B-D52-A2-P1	
<b>5/3-way mid-position valve, single solenoid, without pilot valves</b>					
	Internal pilot air supply	Normally closed	546748	VSVA-B-P53C-A2-P1	
		Normally open	546744	VSVA-B-P53U-A2-P1	
		Normally exhausted	546746	VSVA-B-P53E-A2-P1	
<b>Pilot valve to ISO 15218</b>					
	Square plug, type C to EN 175301-803	12 V DC	MO non-detenting	546257	VSCS-B-M32-MH-WA-5C1
			MO, detenting/non-detenting	571062	VSCS-B-M32-MD-WA-5C1
		24 V DC	MO non-detenting	546256	VSCS-B-M32-MH-WA-1C1
			MO, detenting/non-detenting	571061	VSCS-B-M32-MD-WA-1C1
		24 V AC	MO non-detenting	546258	VSCS-B-M32-MH-WA-1AC1
			MO, detenting/non-detenting	571063	VSCS-B-M32-MD-WA-1AC1
	Square plug, type C to EN 175301-803, with protective earth conductor	110 V AC	MO non-detenting	546259	VSCS-B-M32-MH-WA-2AC1
			MO, detenting/non-detenting	571064	VSCS-B-M32-MD-WA-2AC1
		230 V AC	MO non-detenting	546260	VSCS-B-M32-MH-WA-3AC1
			MO, detenting/non-detenting	571065	VSCS-B-M32-MD-WA-3AC1
	M12 round plug to IEC 61076-2-101	24 V DC	MO non-detenting	573214	VSCS-B-M32-MH-WA-1R3
			MO, detenting/non-detenting	573215	VSCS-B-M32-MD-WA-1R3

MO Manual override

# Solenoid valves VSVA, with pilot interface to ISO 15218

FESTO

Technical data – Width 26 mm

-  Flow rate  
Max. 1400 l/min

-  Voltage  
12, 24 V DC  
24, 110, 230 V AC

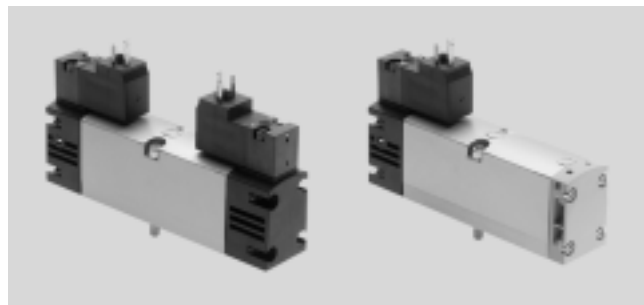

General technical data						
Valve function	2x2/2-way	2x 3/2-way	5/2		5/3	
Normal position	C <sup>1)</sup>	C <sup>1)</sup> , U <sup>2)</sup> , H <sup>4)</sup> , N <sup>5)</sup> , F <sup>6)</sup> , W <sup>7)</sup>	–	–	C <sup>1)</sup>	U <sup>2)</sup> E <sup>3)</sup>
Stable position	Monostable	Monostable	Monostable	Bistable	Monostable	
Reset method: pneumatic spring	Yes	Yes	Yes	–	No	
Reset method: mechanical spring	No	No	Yes	–	Yes	
Design	Piston spool					
Sealing principle	Soft					
Type of actuation	Electrical					
Type of pilot control	Piloted					
Pilot interface	To ISO 15218					
Pilot air supply port	Internal or external					
Pilot air supply, exhaust air	Not ducted according to standard or ducted					
Direction of flow	Non-reversible or reversible	Non-reversible or reversible only	Reversible with external pilot air supply			
Exhaust air function	With flow control					
Manual override	Non-detenting, non-detenting/detenting					
Type of mounting	On sub-base					
Mounting position	Any					
Nominal width [mm]	9					
Flow rate of valve [l/min]	1350	1250	1400	–	1400	
Flow rate of valve on individual sub-base [l/min]	1000	1000	1100	–	1100	
Flow rate of pneumatically interlinked valve [l/min]	1000	900	1100	–	1000	
Standard nominal flow rate [l/min]	1000	900	1100	–	1000	
Switching time on/off, pneumatic spring [ms]	20/28	20/28	35/43	–	–	
Switching time on/off, mechanical spring [ms]	–	–	26/56	–	23/58	
Switching time on/off, for N, F and W [ms]	–	28/20	–	–	–	
Changeover time [ms]	–	–	–	18	35	
Non-overlapping	Yes					
Valve size [mm]	26					
Ports on the sub-base	1, 2, 3, 4, 5	G1/4				
	12, 14	M5				
Tightening torque for valve mounting [Nm]	1.8 ... 2.2					
Product weight	Without pilot valve	[g]	229	229	142	229
	Solenoid valve	[g]	305	305	180	305
Noise level [dB (A)]	85					
Conforms to standard	ISO 15407-1, VDMA 24563 and for pilot valve interface ISO 15218					

- 1) C=Normally closed
- 2) U = Normally open
- 3) E = Normally exhausted
- 4) H=2x 3/2-way valve in one housing with 1x normally closed and 1x normally open
- 5) N=Normally closed, reverse operation, i.e. the pressure supply ports are 3 and 5, venting is via port 1
- 6) F=Normally open, reverse operation, i.e. the pressure supply ports are 3 and 5, venting is via port 1
- 7) W=2x 3/2-way valve in one housing with 1x normally closed and 1x normally open, reverse operation, i.e. the pressure supply ports are 3 and 5, venting is via port 1

# Solenoid valves VSVA, with pilot interface to ISO 15218

Technical data – Width 26 mm

Safety data			
Type	VSVA-...-1C1	VSVA-...-P1 VSVA-...-5C1 VSVA-...-1AC1	VSVA-...-2AC1 VSVA-...-3AC1
Note on forced switch on/off	Switching frequency min. 1/week		
CE marking (see declaration of conformity)	–		To EU Low Voltage Directive
Max. positive test pulse with 0 signal	[μs]	1000	–
Max. negative test pulse with 1 signal	[μs]	800	–
Shock resistance	Shock test with severity level 2 to FN 942017-5 and EN 60068-2-27		
Vibration resistance	Transport application test with severity level 2 to FN 942017-4 and EN 60068-2-6		

Operating and environmental conditions						
Valve function		2x2/2-way	2x 3/2-way	5/2-way	5/3-way	
Operating medium	Compressed air to ISO 8573-1:2010 [7:4:4]					
Pilot medium	Compressed air to ISO 8573-1:2010 [7:4:4]					
Note on operating/pilot medium	Lubricated operation possible (in which case lubricated operation will always be required)					
Operating pressure	Internal pilot air supply	[bar]	2 ... 10	2 ... 10	2 ... 10, 3 ... 10 with mechanical spring	3 ... 10
	External pilot air supply	[bar]	2 ... 10	2 ... 10	–0.9 ... 16	–0.9 ... 16
Pilot pressure with pneumatic spring	[bar]	3 ... 10 <sup>1)</sup>	3 ... 10 <sup>1)</sup>	3 ... 10	–	
Pilot pressure with mechanical spring	[bar]	–	–	3 ... 10	3 ... 10	
Ambient temperature	[°C]	–5 ... +50				
Temperature of medium	[°C]	–5 ... +50				

1) Pilot pressure dependent on operating pressure → Graph

## Minimum pilot pressure p12, p14 as a function of operating pressure p1 (external pilot air supply)

2x 3/2-way solenoid valve

5/2-way solenoid valve and 5/3-way solenoid valve

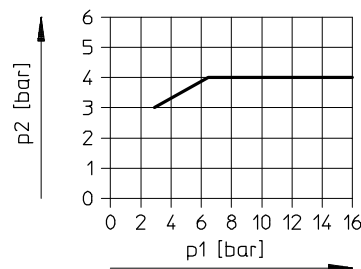
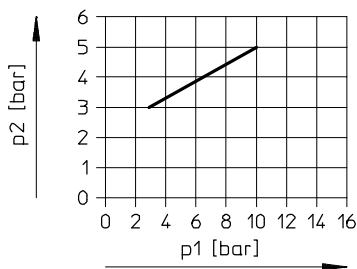

Electrical data			
Electrical connection	Plug, square design to EN 175301-803, type C, 110 V/230 V AC with protective earth conductor		M12 plug, round design
Operating voltage	DC voltage	[V DC]	12, 24 +10%/–15%
	Alternating voltage	[V AC]	24, 110, 230 +10%/–15%
Characteristic coil data	DC voltage	[W]	1.8
	AC voltage	[VA]	At 24 V AC: • 3.1 pickup power • 2.3 holding power At 110 V AC and 230 V AC: • 2.9 pickup power • 2.1 holding power
Duty cycle	[%]	100	
Degree of protection to EN 60529	IP65, Nema 4 (in combination with plug socket)		

# Solenoid valves VSVA, with pilot interface to ISO 15218

Technical data – Width 26 mm



## Materials

Sectional view

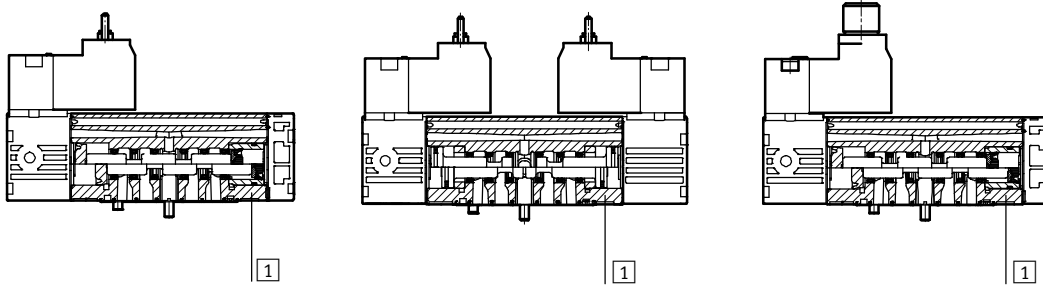

1	Housing	Die-cast aluminium
-	Seals	HNBR, NBR
-	Screws	Galvanised steel
-	Note on materials	RoHS compliant

## Dimensions

Download CAD data → [www.festo.com](http://www.festo.com)

5/2-way valve, single solenoid with plug type C, VSVA-B-M52...C1

5/2-way valve, single solenoid with M12 plug, VSVA-B-M52...R3

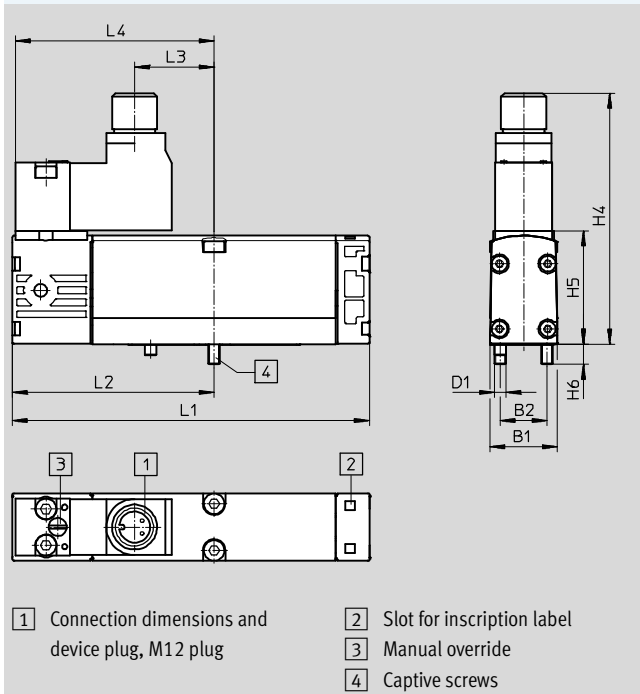
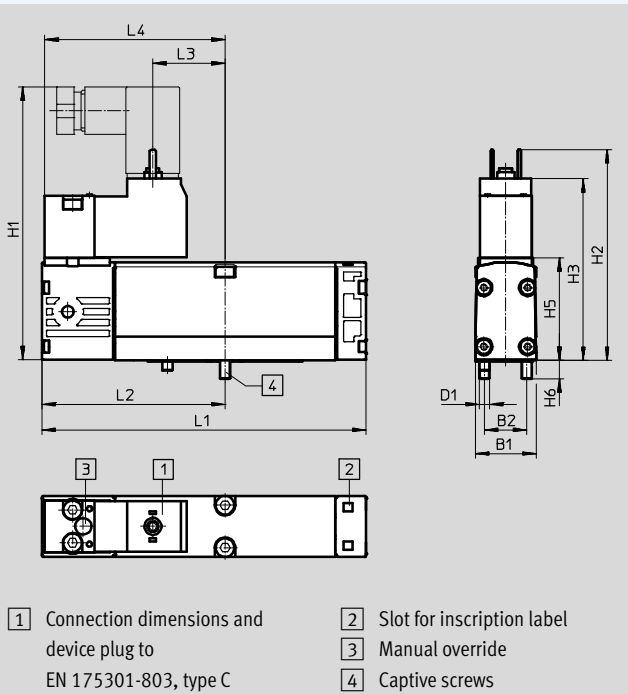

	B1	B2	D1	H1	H2	H3	H4	H5	H6	L1	L2	L3	L4
VSVA-B-M52...C1	26.3	19	M4	89.2	71.2	62.6	-	39.3	7	113.1	63.1	29.8	61.6
VSVA-B-M52...R3	26.3	19	M4	-	-	-	76.1	39.3	7	113.1	63.1	29.8	61.6

# Solenoid valves VSVA, with pilot interface to ISO 15218

Technical data – Width 26 mm

## Dimensions

Download CAD data → [www.festo.com](http://www.festo.com)

2x 2/2-way valve, 2x 3/2-way valve, 5/2-way valve, double solenoid, 5/3-way valve

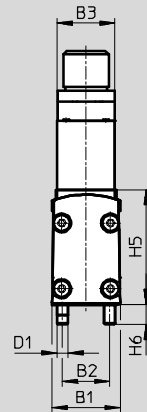
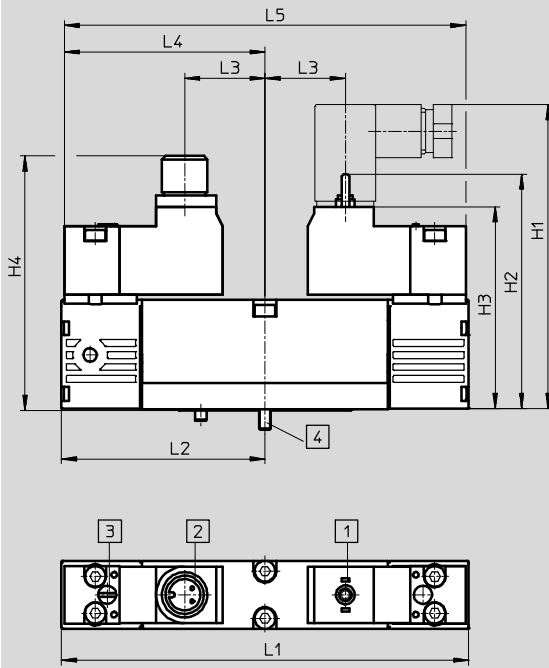

- 1 Connection dimensions and device plug to EN 175301-803, type C
- 2 Connection dimensions and device plug, M12 plug
- 3 Manual override
- 4 Captive screws

	B1	B2	B3	D1	H1	H2	H3	H4	H5	H6	L1	L2	L3	L4	L5
VSVA-B-T22C	26.3	19	15.2	M4	89.2	71.2	62.6	76.1	39.3	7	126.2	63.1	29.8	61.6	123.2
VSVA-B-T32															
VSVA-B-B52															
VSVA-B-D52															
VSVA-B-P53															

## Dimensions

Download CAD data → [www.festo.com](http://www.festo.com)

Pilot valve with plug type C, VSCS-...C1

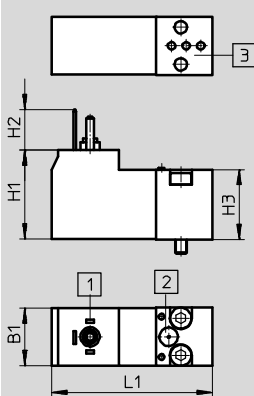

- 1 Connection dimensions and device plug to EN 175301-803, type C
- 2 Manual override
- 3 Pneumatic port pattern to ISO 15218

Pilot valve with M12 plug, VSCS-...R3

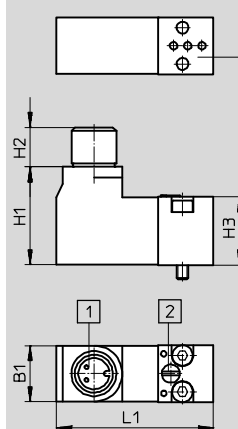

- 1 Connection dimensions and device plug, M12 plug
- 2 Manual override
- 3 Pneumatic port pattern to ISO 15218

	B1	H1	H2	H3	L1
VSCS-...C1	15.2	23.2	10.5	18.2	41.9
VSCS-...R3	15	26.1	10.6	18.2	41.9

# Solenoid valves VSVA, with pilot interface to ISO 15218

Technical data – Width 26 mm

Ordering data – Pilot control assembled						
Code	Circuit symbol		Part No.	Type		
2x 2/2-way solenoid valve						
T22C	-	Order via online configurator	-	-		
2x 3/2-way solenoid valve, with pilot control with square plug, type C to EN 175301-803						
K		Normal position: 2x closed	Internal pilot air supply	24 V DC	546692	VSVA-B-T32C-AH-A1-1C1
				12 V DC	547128	VSVA-B-T32C-AH-A1-5C1
				230 V AC	547208	VSVA-B-T32C-AH-A1-3AC1
				110 V AC	547168	VSVA-B-T32C-AH-A1-2AC1
				24 V AC	547088	VSVA-B-T32C-AH-A1-1AC1
N		Normal position: 2x open	Internal pilot air supply	24 V DC	546694	VSVA-B-T32U-AH-A1-1C1
				12 V DC	547130	VSVA-B-T32U-AH-A1-5C1
				230 V AC	547210	VSVA-B-T32U-AH-A1-3AC1
				110 V AC	547170	VSVA-B-T32U-AH-A1-2AC1
				24 V AC	547090	VSVA-B-T32U-AH-A1-1AC1
H		Normal position: 1x closed 1x open	Internal pilot air supply	24 V DC	547066	VSVA-B-T32H-AH-A1-1C1
				12 V DC	547132	VSVA-B-T32H-AH-A1-5C1
				230 V AC	547212	VSVA-B-T32H-AH-A1-3AC1
				110 V AC	547172	VSVA-B-T32H-AH-A1-2AC1
				24 V AC	547092	VSVA-B-T32H-AH-A1-1AC1
K		Normal position: 2x closed	External pilot air supply	24 V DC	547068	VSVA-B-T32C-AZH-A1-1C1
				12 V DC	547148	VSVA-B-T32C-AZH-A1-5C1
				230 V AC	547228	VSVA-B-T32C-AZH-A1-3AC1
				110 V AC	547188	VSVA-B-T32C-AZH-A1-2AC1
				24 V AC	547108	VSVA-B-T32C-AZH-A1-1AC1
N		Normal position: 2x open	External pilot air supply	24 V DC	547070	VSVA-B-T32U-AZH-A1-1C1
				12 V DC	547150	VSVA-B-T32U-AZH-A1-5C1
				230 V AC	547230	VSVA-B-T32U-AZH-A1-3AC1
				110 V AC	547190	VSVA-B-T32U-AZH-A1-2AC1
				24 V AC	547110	VSVA-B-T32U-AZH-A1-1AC1
H		Normal position: 1x closed 1x open	External pilot air supply	24 V DC	547072	VSVA-B-T32H-AZH-A1-1C1
				12 V AC	547152	VSVA-B-T32H-AZH-A1-5C1
				230 V AC	547232	VSVA-B-T32H-AZH-A1-3AC1
				110 V AC	547192	VSVA-B-T32H-AZH-A1-2AC1
				24 V AC	547112	VSVA-B-T32H-AZH-A1-1AC1



# Solenoid valves VSVA, with pilot interface to ISO 15218

Technical data – Width 26 mm

Ordering data – Pilot control assembled						
Code	Circuit symbol				Part No.	Type
<b>5/2-way valve, single solenoid, with pilot control with square plug, type C to EN 175301-803</b>						
M		Pneumatic spring	Internal pilot air supply	24 V DC	546700	VSVA-B-M52-AH-A1-1C1
				12 V DC	547138	VSVA-B-M52-AH-A1-5C1
				230 V AC	547218	VSVA-B-M52-AH-A1-3AC1
				110 V AC	547178	VSVA-B-M52-AH-A1-2AC1
				24 V AC	547098	VSVA-B-M52-AH-A1-1AC1
O		Mechanical spring	Internal pilot air supply	24 V DC	546702	VSVA-B-M52-MH-A1-1C1
				12 V DC	547140	VSVA-B-M52-MH-A1-5C1
				230 V AC	547220	VSVA-B-M52-MH-A1-3AC1
				110 V AC	547180	VSVA-B-M52-MH-A1-2AC1
				24 V AC	547100	VSVA-B-M52-MH-A1-1AC1
M		Pneumatic spring	External pilot air supply	24 V DC	547078	VSVA-B-M52-AZH-A1-1C1
				12 V DC	547158	VSVA-B-M52-AZH-A1-5C1
				230 V AC	547238	VSVA-B-M52-AZH-A1-3AC1
				110 V AC	547198	VSVA-B-M52-AZH-A1-2AC1
				24 V AC	547118	VSVA-B-M52-AZH-A1-1AC1
O		Mechanical spring	External pilot air supply	24 V DC	547080	VSVA-B-M52-MZH-A1-1C1
				12 V DC	547160	VSVA-B-M52-MZH-A1-5C1
				230 V AC	547240	VSVA-B-M52-MZH-A1-3AC1
				110 V AC	547200	VSVA-B-M52-MZH-A1-2AC1
				24 V AC	547120	VSVA-B-M52-MZH-A1-1AC1
<b>5/2-way valve, double solenoid, with pilot control with square plug, type C to EN 175301-803</b>						
J		Dominant 1st signal	Internal pilot air supply	24 V DC	546696	VSVA-B-B52-H-A1-1C1
				12 V DC	547134	VSVA-B-B52-H-A1-5C1
				230 V AC	547214	VSVA-B-B52-H-A1-3AC1
				110 V AC	547174	VSVA-B-B52-H-A1-2AC1
				24 V AC	547094	VSVA-B-B52-H-A1-1AC1
D		Dominant at 14	Internal pilot air supply	24 V DC	546698	VSVA-B-D52-H-A1-1C1
				12 V DC	547136	VSVA-B-D52-H-A1-5C1
				230 V AC	547216	VSVA-B-D52-H-A1-3AC1
				110 V AC	547176	VSVA-B-D52-H-A1-2AC1
				24 V AC	547096	VSVA-B-D52-H-A1-1AC1
J		Dominant 1st signal	External pilot air supply	24 V DC	547074	VSVA-B-B52-ZH-A1-1C1
				12 V DC	547154	VSVA-B-B52-ZH-A1-5C1
				230 V AC	547234	VSVA-B-B52-ZH-A1-3AC1
				110 V AC	547194	VSVA-B-B52-ZH-A1-2AC1
				24 V AC	547114	VSVA-B-B52-ZH-A1-1AC1
D		Dominant at 14	External pilot air supply	24 V DC	547076	VSVA-B-D52-ZH-A1-1C1
				12 V DC	547156	VSVA-B-D52-ZH-A1-5C1
				230 V AC	547236	VSVA-B-D52-ZH-A1-3AC1
				110 V AC	547196	VSVA-B-D52-ZH-A1-2AC1
				24 V AC	547116	VSVA-B-D52-ZH-A1-1AC1





# Solenoid valves VSVA, with pilot interface to ISO 15218

Technical data – Width 26 mm

Ordering data – Pilot control assembled						
Code	Circuit symbol			Part No.	Type	
5/3-way solenoid valve, with pilot control with square plug, type C to EN 175301-803						
G		Normal position: closed	Internal pilot air supply	24 V DC	<b>546708</b>	<b>VSVA-B-P53C-H-A1-1C1</b>
				12 V DC	<b>547146</b>	<b>VSVA-B-P53C-H-A1-5C1</b>
				230 V AC	<b>547226</b>	<b>VSVA-B-P53C-H-A1-3AC1</b>
				110 V AC	<b>547186</b>	<b>VSVA-B-P53C-H-A1-2AC1</b>
				24 V AC	<b>547106</b>	<b>VSVA-B-P53C-H-A1-1AC1</b>
B		Normal position: open	Internal pilot air supply	24 V DC	<b>546704</b>	<b>VSVA-B-P53U-H-A1-1C1</b>
				12 V DC	<b>547142</b>	<b>VSVA-B-P53U-H-A1-5C1</b>
				230 V AC	<b>547222</b>	<b>VSVA-B-P53U-H-A1-3AC1</b>
				110 V AC	<b>547182</b>	<b>VSVA-B-P53U-H-A1-2AC1</b>
				24 V AC	<b>547102</b>	<b>VSVA-B-P53U-H-A1-1AC1</b>
E		Normal position: exhausted	Internal pilot air supply	24 V DC	<b>546706</b>	<b>VSVA-B-P53E-H-A1-1C1</b>
				12 V DC	<b>547144</b>	<b>VSVA-B-P53E-H-A1-5C1</b>
				230 V AC	<b>547224</b>	<b>VSVA-B-P53E-H-A1-3AC1</b>
				110 V AC	<b>547184</b>	<b>VSVA-B-P53E-H-A1-2AC1</b>
				24 V AC	<b>547104</b>	<b>VSVA-B-P53E-H-A1-1AC1</b>
G		Normal position: closed	External pilot air supply	24 V DC	<b>547086</b>	<b>VSVA-B-P53C-ZH-A1-1C1</b>
				12 V DC	<b>547166</b>	<b>VSVA-B-P53C-ZH-A1-5C1</b>
				230 V AC	<b>547246</b>	<b>VSVA-B-P53C-ZH-A1-3AC1</b>
				110 V AC	<b>547206</b>	<b>VSVA-B-P53C-ZH-A1-2AC1</b>
				24 V AC	<b>547126</b>	<b>VSVA-B-P53C-ZH-A1-1AC1</b>
B		Normal position: open	External pilot air supply	24 V DC	<b>547082</b>	<b>VSVA-B-P53U-ZH-A1-1C1</b>
				12 V DC	<b>547162</b>	<b>VSVA-B-P53U-ZH-A1-5C1</b>
				230 V AC	<b>547242</b>	<b>VSVA-B-P53U-ZH-A1-3AC1</b>
				110 V AC	<b>547202</b>	<b>VSVA-B-P53U-ZH-A1-2AC1</b>
				24 V AC	<b>547122</b>	<b>VSVA-B-P53U-ZH-A1-1AC1</b>
E		Normal position: exhausted	External pilot air supply	24 V DC	<b>547084</b>	<b>VSVA-B-P53E-ZH-A1-1C1</b>
				12 V DC	<b>547164</b>	<b>VSVA-B-P53E-ZH-A1-5C1</b>
				230 V AC	<b>547244</b>	<b>VSVA-B-P53E-ZH-A1-3AC1</b>
				110 V AC	<b>547204</b>	<b>VSVA-B-P53E-ZH-A1-2AC1</b>
				24 V AC	<b>547124</b>	<b>VSVA-B-P53E-ZH-A1-1AC1</b>

# Solenoid valves VSVA, with pilot interface to ISO 15218

Technical data – Width 26 mm without pilot valve

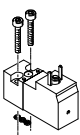
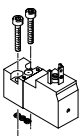
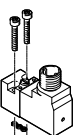
Ordering data – Pilot control separate				Part No.	Type
<b>2x 3/2-way valve without pilot valves</b>					
	Internal pilot air supply	2x normally closed	546731	VSVA-B-T32C-A-A1-P1	
		2x normally open	546733	VSVA-B-T32U-A-A1-P1	
<b>5/2-way single solenoid valve without pilot valve</b>					
	Internal pilot air supply	Pneumatic	546739	VSVA-B-M52-A-A1-P1	
		Mechanical spring	546741	VSVA-B-M52-M-A1-P1	
<b>5/2-way double solenoid valve without pilot valve</b>					
	Internal pilot air supply	Dominant 1st signal	546735	VSVA-B-B52-A1-P1	
		Dominant at 14	546737	VSVA-B-D52-A1-P1	
<b>5/3-way mid-position valve, single solenoid, without pilot valves</b>					
	Internal pilot air supply	Normally closed	546747	VSVA-B-P53C-A1-P1	
		Normally open	546743	VSVA-B-P53U-A1-P1	
		Normally exhausted	546745	VSVA-B-P53E-A1-P1	
<b>Pilot valve to ISO 15218</b>					
	Square plug, type C to EN 175301-803	12 V DC	MO non-detenting	546257	VSCS-B-M32-MH-WA-5C1
			MO detenting	571062	VSCS-B-M32-MD-WA-5C1
		24 V DC	MO non-detenting	546256	VSCS-B-M32-MH-WA-1C1
			MO detenting	571061	VSCS-B-M32-MD-WA-1C1
		24 V AC	MO non-detenting	546258	VSCS-B-M32-MH-WA-1AC1
			MO detenting	571063	VSCS-B-M32-MD-WA-1AC1
	Square plug, type C to EN 175301-803, with protective earth conductor	110 V AC	MO non-detenting	546259	VSCS-B-M32-MH-WA-2AC1
			MO detenting	571064	VSCS-B-M32-MD-WA-2AC1
		230 V AC	MO non-detenting	546260	VSCS-B-M32-MH-WA-3AC1
			MO detenting	571065	VSCS-B-M32-MD-WA-3AC1
	M12 round plug to IEC 61076-2-101	24 V DC	MO non-detenting	573214	VSCS-B-M32-MH-WA-1R3
			MO detenting	573215	VSCS-B-M32-MD-WA-1R3

MO Manual override

# Solenoid valves VSVA, with pilot interface to ISO 15218

Technical data – Width 26 mm, valve with position detection

FESTO

-  Flow rate  
Max. 1400 l/min

-  Voltage  
24 V DC



## ISO valves with switching position sensing for safety-related pneumatic components

The 5/2-way single solenoid valve with spring return contains an inductive sensor that monitors the normal position of the piston spool valve. This valve is not a safety device in accordance with the Machinery Directive 2006/42/EC.

For use in higher categories, the sensor signal from the valve must be evaluated by a control unit. This valve is suitable for use in safety-related parts of control systems to EN ISO 13849-1. This valve is designed for installation in machines

and automation systems and must only be used in industrial applications (high-demand mode). The circuit symbol represents a valve with a proximity sensor with switching output signal with a normally open contact. In accordance with

ISO 1219-1, this symbol is used both for normally open contacts and for normally closed contacts. The switching element function of the sensors used here is designed as an N/C contact.

General technical data			
Valve function		5/2-way	
Piston position sensing		Normal position with sensor	
Stable positions		Monostable	
Reset method		Mechanical spring	
Design		Piston spool	
Sealing principle		Soft	
Type of actuation		Electrical	
Type of pilot control		Piloted	
Pilot interface		To ISO 15218	
Pilot air supply port		External	
Pilot air supply, exhaust air		Optionally ducted/not ducted	
Direction of flow		Any	
Exhaust air function		Flow control possible, via flow control plate, via individual sub-base	
Manual override		Covered	
Type of mounting		On sub-base	
Mounting position		Any	
Nominal width	[mm]	9	
Flow rate of valve	[l/min]	1400	
Flow rate of valve on individual sub-base	[l/min]	1100	
Flow rate of pneumatically interlinked valve	[l/min]	1100	
Standard nominal flow rate	[l/min]	1100	
Switching time on/off	[ms]	21/41	
Non-overlapping		Yes	
Width	[mm]	26	
Ports on the sub-base	1, 2, 3, 4, 5 12, 14	G1/4 M5	
Tightening torque for valve mounting	[Nm]	1.8 ... 2.2	
Product weight	With plug M8x1	[g]	289
	With open cable end	[g]	332
Noise level	[dB (A)]	85	
Conforms to standard		ISO 15407-1, VDMA 24563	

# Solenoid valves VSVA, with pilot interface to ISO 15218

Technical data – Width 26 mm, valve with position detection

Safety characteristics	
Note on forced switch on/off	Switching frequency min. 1/week
CE marking (see declaration of conformity)	To EU EMC Directive <sup>1)</sup>
Max. positive test pulse with 0 signal [μs]	1000
Max. negative test pulse with 1 signal [μs]	800
Shock resistance	Shock test with severity level 2 to FN 942017-5 and EN 60068-2-27
Vibration resistance	Transport application test with severity level 2 to FN 942017-4 and EN 60068-2-6

- 1) For information about the applicability of the component see the manufacturer's EC declaration of conformity at: [www.festo.com/sp](http://www.festo.com/sp) → User documentation.  
If the component is subject to restrictions on usage in residential, office or commercial environments or small businesses, further measures to reduce the emitted interference may be necessary.

Operating and environmental conditions	
Operating medium	Compressed air to ISO 8573-1:2010 [7:4:4]
Pilot medium	Compressed air to ISO 8573-1:2010 [7:4:4]
Note on operating/pilot medium	Lubricated operation possible (in which case lubricated operation will always be required)
Operating pressure [bar]	-0.9 ... 10
Pilot pressure [bar]	3 ... 10
Ambient temperature [°C]	-5 ... +50
Temperature of medium [°C]	-5 ... +50

- 1) Pilot pressure dependent on operating pressure → Graph

## Minimum pilot pressure p<sub>2</sub>, p<sub>14</sub> as a function of operating pressure p<sub>1</sub> (external pilot air supply)

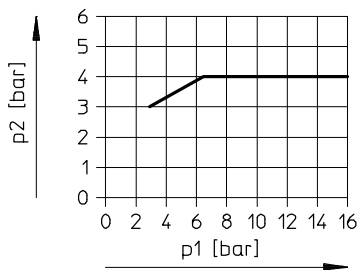

Electrical data	
Electrical connection	Plug, square design to EN 175301-803, type C, without protective earth conductor
Operating voltage [V DC]	24 +10%/-15%
Characteristic coil data [W]	1.8
Duty cycle [%]	100
Signal status display	Via accessories
Degree of protection to EN 60529	IP65, Nema 4 (in combination with plug socket)
Certification	C-Tick

# Solenoid valves VSVA, with pilot interface to ISO 15218



Technical data – Width 26 mm, valve with position detection

Electrical data – Sensor			
Type		VSVA-B-M52-MZ-A1-1C1-AP...	VSVA-B-M52-MZ-A1-1C1-AN...
Electrical connection		Plug, M8x1, 3-pin	Open cable end, 2.5 m
Operating voltage	[V DC]	10 ... 30	10 ... 30
Switching element function		Normally closed contact	Normally closed contact
Measuring principle		Inductive	Inductive
Switching status display sensor		LED	LED
Protection against polarity reversal		For all electrical connections	For all electrical connections
Protection against short circuit		Pulsed	Pulsed
Idle current	[mA]	Max. 10	Max. 10
Output current	[mA]	Max. 200	Max. 200
Switching frequency	[kHz]	Max. 5	Max. 5
Residual ripple	[%]	±10	±10
Voltage drop	[V]	Max. 2	Max. 2
Valve – Sensor switching time	On	[ms]	60
	Off	[ms]	11

Materials	
Housing	Die-cast aluminium, PA
Seals	FPM, NBR
Screws	Galvanised steel
Note on materials	RoHS compliant

## Dimensions Download CAD data → [www.festo.com](http://www.festo.com)

5/2-way valve, single solenoid with plug type C, VSVA-B-M52-MZ-A1-1C1-A...

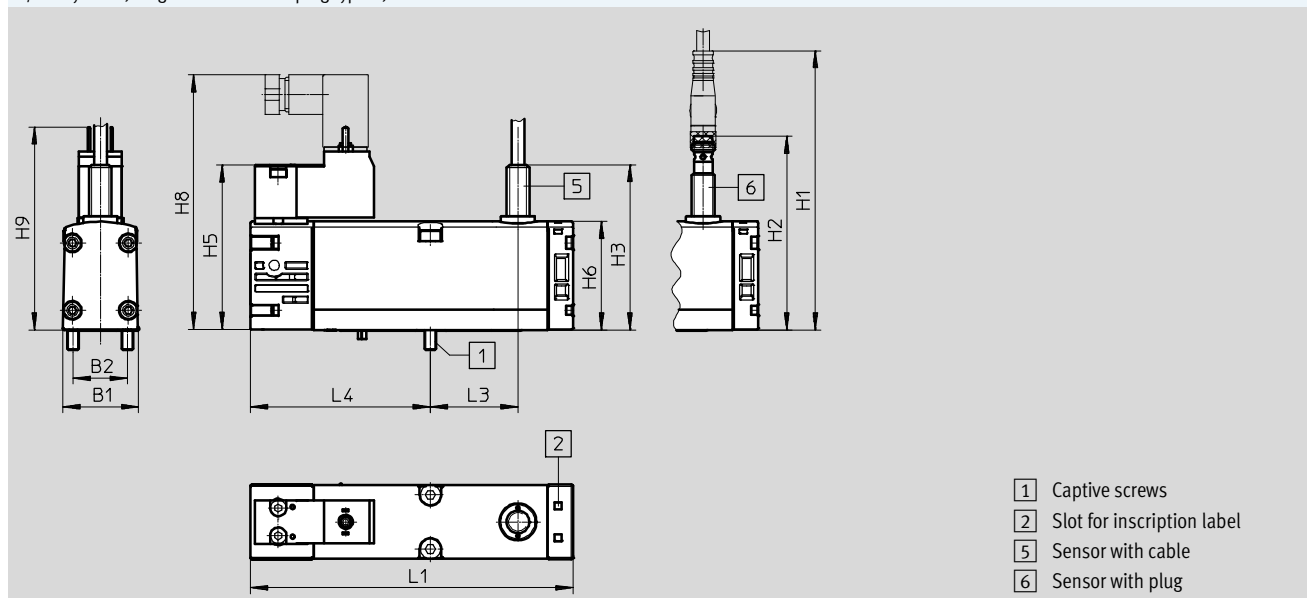



	B1	B2	H1	H2	H3	H5	H6	H8	H9	L1	L3	L4
VSVA-B-M52-MZ-A1-1C1-A...	26.2	19	98	68.2	58	57.8	38	89.6	71.2	113.1	30.7	63.1

# Solenoid valves VSVA, with pilot interface to ISO 15218

FESTO

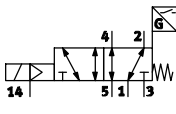
Technical data – Width 26 mm, valve with position detection

Ordering data – Pilot control assembled					
Code	Circuit symbol		Electrical connection for sensor	Part No.	Type
5/2-way valve, single solenoid, with pilot control with square plug, type C to EN 175301-803					
SO		Inductive sensor with PNP output	Plug, M8x1, 3-pin	560726	VSVA-B-M52-MZ-A1-1C1-APP
–			Open cable end, 2.5 m	560725	VSVA-B-M52-MZ-A1-1C1-APC
SQ		Inductive sensor with NPN output	Plug, M8x1, 3-pin	560745	VSVA-B-M52-MZ-A1-1C1-ANP
–			Open cable end, 2.5 m	560744	VSVA-B-M52-MZ-A1-1C1-ANC

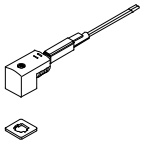
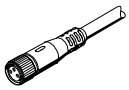
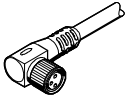
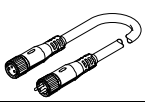
Ordering data – Accessories							
Code		Description		Part No.	Type		
Plug socket for port pattern to EN 175301-803, type C							
–		Angled socket, type C, 3-pin, screw terminal	Cable connector PG7	151687	MSSD-EB		
			Cable connector M12	539712	MSSD-EB-M12		
					Technical data → Internet: meb-ld		
–		For plug socket MSSD, 12 ... 24 V DC		151717	MEB-LD-12-24DC		
Connecting cable for port pattern to EN 175301-803, type C							
GG		Angled socket, type C, with LED Open end, 3-wire	3-pin, cable sheath PVC	2.5 m	151688	KMEB-1-24-2,5-LED	
GH				5 m	151689	KMEB-1-24-5-LED	
GJ				10 m	193457	KMEB-1-24-10-LED	
Connecting cable for electrical connection of the position detection sensor							
GM		Straight socket, M8x1, 3-pin Open end, 3-wire		2.5 m	541333	NEBU-M8G3-K-2,5-LE3	
GN				5 m	541334	NEBU-M8G3-K-5-LE3	
GO		Angled socket, M8x1, 3-pin Open end, 3-wire	–	2.5 m	541338	NEBU-M8W3-K-2,5-LE3	
GP				5 m	541341	NEBU-M8W3-K-5-LE3	
–				Rotatable socket	2.5 m	8001660	NEBU-M8R3-K-2,5-LE3
–					5 m	8001661	NEBU-M8R3-K-5-LE3
GQ		Straight socket, M8x1, 3-pin Straight plug, M8x1, 4-pin		2.5 m	554037	NEBU-M8G3-K-2,5-M8G4	

# Solenoid valves VSVA, with central plug M8x1, M12x1

FESTO

Technical data – Width 18 mm

-  - Flow rate  
Max. 750 l/min

-  - Voltage  
24 V DC



General technical data								
Valve function	2x 3/2-way			5/2-way		5/3-way		
Normal position	C <sup>1)</sup>	U <sup>2)</sup>	H <sup>4)</sup>	–	–	C <sup>1)</sup>	U <sup>2)</sup>	E <sup>3)</sup>
Stable position	Monostable				Bistable		Monostable	
Reset method: pneumatic spring	Yes			Yes	–	No		
Reset method: mechanical spring	No			Yes	–	Yes		
Design	Piston spool							
Sealing principle	Soft							
Type of actuation	Electrical							
Type of pilot control	Piloted							
Pilot air supply port	Internal or external							
Direction of flow	Non-reversible			Reversible with external pilot air supply				
Exhaust air function	With flow control							
Manual override	Non-detenting							
Type of mounting	On sub-base							
Mounting position	Any							
Nominal width	[mm]	5						
Flow rate of valve	[l/min]	600		750		650		
Flow rate of valve on individual sub-base	[l/min]	450		550		500		
Flow rate of pneumatically interlinked valve	[l/min]	400		550		450		
Standard nominal flow rate	[l/min]	400		550		450		
Switching time on/off, pneumatic spring	[ms]	10/22		20/25		–		–
Switching time on/off, mechanical spring	[ms]	–		12/34		–		15/36
Changeover time	[ms]	–		–		10		–
Non-overlapping	Yes							
Width	[mm]	18						
Ports on the sub-base	1, 2, 3, 4, 5	G1/8						
	12, 14	M5						
Tightening torque for valve mounting	[Nm]	0.9 ... 1.1						
Product weight	[g]	140						
Noise level	[dB (A)]	85						
Conforms to standard	ISO 15407-1, VDMA 24563							

- 1) C=Normally closed
- 2) U = Normally open
- 3) E = Normally exhausted
- 4) H=2x 3/2-way valve in one housing with 1x normally closed and 1x normally open



# Solenoid valves VSVA, with central plug M8x1, M12x1

Technical data – Width 18 mm

Safety characteristics	
Note on forced switch on/off	Switching frequency min. 1/week
CE marking (see declaration of conformity)	To EU EMC Directive <sup>1)</sup>
Max. positive test pulse with 0 signal [μs]	500
Max. negative test pulse with 1 signal [μs]	500
Shock resistance	Shock test with severity level 2 to FN 942017-5 and EN 60068-2-27
Vibration resistance	Transport application test with severity level 2 to FN 942017-4 and EN 60068-2-6

- 1) For information about the applicability of the component see the manufacturer's EC declaration of conformity at: [www.festo.com/sp](http://www.festo.com/sp) → User documentation.  
If the component is subject to restrictions on usage in residential, office or commercial environments or small businesses, further measures to reduce the emitted interference may be necessary.

Operating and environmental conditions				
Valve function		2x3/2-way	5/2-way	5/3-way
Operating medium		Compressed air to ISO 8573-12010 [7:4:4]		
Note on operating/pilot medium		Lubricated operation possible (in which case lubricated operation will always be required)		
Operating pressure	Internal pilot air supply [bar]	3 ... 8	3 ... 8	3 ... 8
	External pilot air supply [bar]	3 ... 10	-0.9 ... 10	-0.9 ... 10
Pilot pressure [bar]		3 ... 8 <sup>1)</sup>	3 ... 8	3 ... 8
Ambient temperature [°C]		-5 ... +50		
Temperature of medium [°C]		-5 ... +50		
Corrosion resistance class CRC <sup>2)</sup>		2		
Certification		c CSA us (OL)		
		c UL us - Recognized (OL)		
		C-Tick		

- 1) Pilot pressure dependent on operating pressure → Graph  
2) Corrosion resistance class CRC 2 to Festo standard FN 940070  
Moderate corrosion stress. Indoor applications in which condensation may occur. External visible parts with primarily decorative requirements for the surface and which are in direct contact with the ambient atmosphere typical for industrial applications.

### Minimum pilot pressure p<sub>12</sub>, p<sub>14</sub> as a function of operating pressure p<sub>1</sub> (external pilot air supply) for the 2x 3/2-way solenoid valves

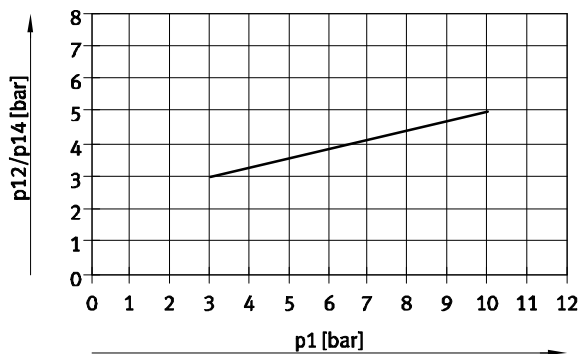

Electrical data			
Electrical connection		Central plug, round design, M8x1 4-pin or M12x1 3-pin	
Characteristic coil data	Voltage [V DC]	24±10% = 21.6 ... 26.4	
	Performance [W]	High-current phase: 2.4 ; Low-current phase: 1 <sup>1)</sup>	
Duty cycle		%	
Degree of protection to EN 60529		IP65 (in combination with plug socket)	
Protective circuit and LED		Integrated in the valve	

- 1) Controlled by integrated current reduction

# Solenoid valves VSVA, with central plug M8x1, M12x1

Technical data – Width 18 mm

## Materials

Sectional view

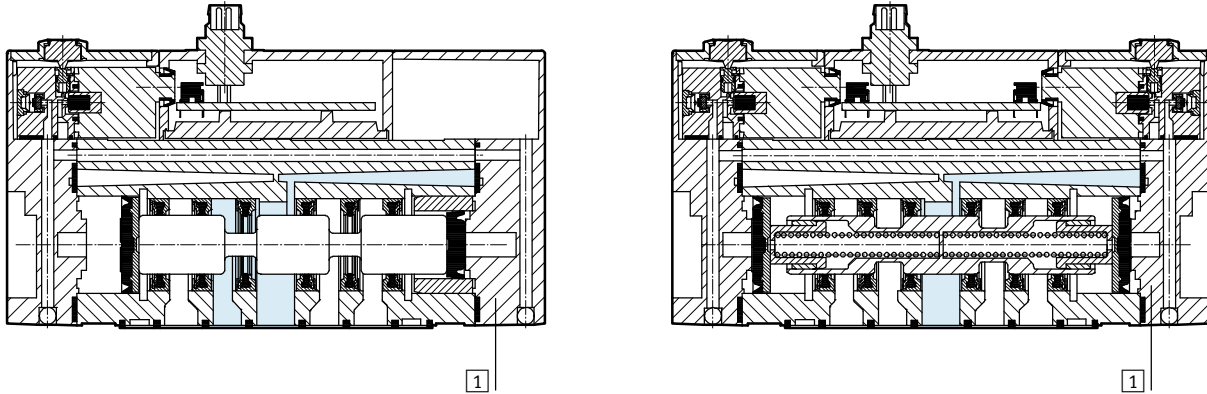

1	Housing	Die-cast aluminium, POM
-	Seals	NBR
-	Note on materials	RoHS compliant

## Dimensions

Download CAD data → [www.festo.com](http://www.festo.com)

Valve with central plug M8x1, VSVA-B-...-1R2L

Valve with central plug M12x1, VSVA-B-...-1R5L

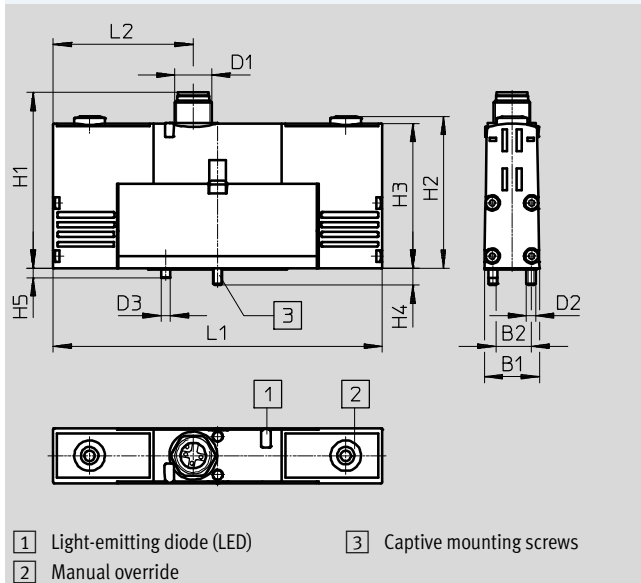
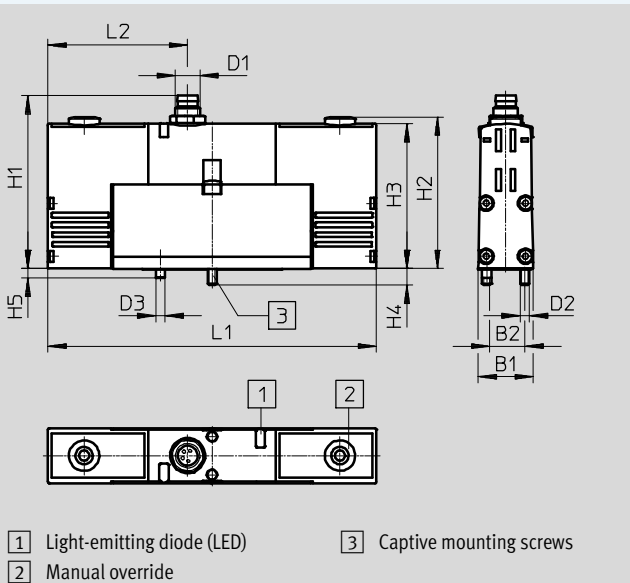

Type	B1	B2	D1	D2	D3	H1	H2	H3	H4	H5	L1	L2
VSVA-B-...-1R2L	18	12.5	M8x1	M3	3	54.4	49.8	47.6	5.4	3	107.8	46.9
VSVA-B-...-1R5L			M12x1			58.2						

## Pin allocation

M8x1

M12x1

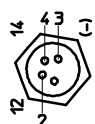

- 1 Unused
- 2 Signal (+) solenoid 12/10
- 3 com (-)
- 4 Signal (+) Solenoid 14/10

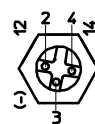

- 2 Signal (+) Solenoid 12
- 3 com (-)
- 4 Signal (+) Solenoid 14

# Solenoid valves VSVA, with central plug M8x1, M12x1

Technical data – Width 18 mm

Ordering data						
Code	Circuit symbol			Part No.	Type	
<b>2x 3/2-way solenoid valve</b>						
K		Normal position: 2x closed	Internal pilot air supply	M8x1	534771	VSVA-B-T32C-AH-A2-1R2L
				M12x1	546764	VSVA-B-T32C-AH-A2-1R5L
N		Normal position: 2x open	Internal pilot air supply	M8x1	534772	VSVA-B-T32U-AH-A2-1R2L
				M12x1	546765	VSVA-B-T32U-AH-A2-1R5L
H		Normal position: 1x closed 1x open	Internal pilot air supply	M8x1	534773	VSVA-B-T32H-AH-A2-1R2L
				M12x1	546766	VSVA-B-T32H-AH-A2-1R5L
K		Normal position: 2x closed	External pilot air supply	M8x1	534781	VSVA-B-T32C-AZH-A2-1R2L
				M12x1	546774	VSVA-B-T32C-AZH-A2-1R5L
N		Normal position: 2x open	External pilot air supply	M8x1	534782	VSVA-B-T32U-AZH-A2-1R2L
				M12x1	546775	VSVA-B-T32U-AZH-A2-1R5L
H		Normal position: 1x closed 1x open	External pilot air supply	M8x1	534783	VSVA-B-T32H-AZH-A2-1R2L
				M12x1	546776	VSVA-B-T32H-AZH-A2-1R5L
<b>5/2-way valve, single solenoid</b>						
M		Pneumatic spring	Internal pilot air supply	M8x1	534774	VSVA-B-M52-AH-A2-1R2L
				M12x1	546767	VSVA-B-M52-AH-A2-1R5L
O		Mechanical spring	Internal pilot air supply	M8x1	534775	VSVA-B-M52-MH-A2-1R2L
				M12x1	546768	VSVA-B-M52-MH-A2-1R5L
M		Pneumatic spring	External pilot air supply	M8x1	534784	VSVA-B-M52-AZH-A2-1R2L
				M12x1	546777	VSVA-B-M52-AZH-A2-1R5L
O		Mechanical spring	External pilot air supply	M8x1	534785	VSVA-B-M52-MZH-A2-1R2L
				M12x1	546778	VSVA-B-M52-MZH-A2-1R5L

# Solenoid valves VSVA, with central plug M8x1, M12x1



Technical data – Width 18 mm

Ordering data						
Code	Circuit symbol			Part No.	Type	
<b>5/2-way valve, double solenoid</b>						
J		Dominant 1st signal	Internal pilot air supply	M8x1	534776	VSVA-B-B52-H-A2-1R2L
				M12x1	546769	VSVA-B-B52-H-A2-1R5L
D		Dominant at 14	Internal pilot air supply	M8x1	534777	VSVA-B-D52-H-A2-1R2L
				M12x1	546770	VSVA-B-D52-H-A2-1R5L
J		Dominant 1st signal	External pilot air supply	M8x1	534786	VSVA-B-B52-ZH-A2-1R2L
				M12x1	546779	VSVA-B-B52-ZH-A2-1R5L
D		Dominant at 14	External pilot air supply	M8x1	534787	VSVA-B-D52-ZH-A2-1R2L
				M12x1	546780	VSVA-B-D52-ZH-A2-1R5L
<b>5/3-way valve</b>						
G		Normally closed	Internal pilot air supply	M8x1	534778	VSVA-B-P53C-H-A2-1R2L
				M12x1	546771	VSVA-B-P53C-H-A2-1R5L
B		Normally open	Internal pilot air supply	M8x1	534780	VSVA-B-P53U-H-A2-1R2L
				M12x1	546773	VSVA-B-P53U-H-A2-1R5L
E		Normally exhausted	Internal pilot air supply	M8x1	534779	VSVA-B-P53E-H-A2-1R2L
				M12x1	546772	VSVA-B-P53E-H-A2-1R5L
G		Normally closed	External pilot air supply	M8x1	534788	VSVA-B-P53C-ZH-A2-1R2L
				M12x1	546781	VSVA-B-P53C-ZH-A2-1R5L
B		Normally open	External pilot air supply	M8x1	534790	VSVA-B-P53U-ZH-A2-1R2L
				M12x1	546783	VSVA-B-P53U-ZH-A2-1R5L
E		Normally exhausted	External pilot air supply	M8x1	534789	VSVA-B-P53E-ZH-A2-1R2L
				M12x1	546782	VSVA-B-P53E-ZH-A2-1R5L

# Solenoid valves VSVA, with central plug M8x1, M12x1

FESTO

Technical data – Width 26 mm

-  - Flow rate  
Max. 1400 l/min

-  - Voltage  
24 V DC



General technical data									
Valve function	2x 3/2-way			5/2-way		5/3-way			
Normal position	C <sup>1)</sup>	U <sup>2)</sup>	H <sup>4)</sup>	–	–	C <sup>1)</sup>	U <sup>2)</sup>	E <sup>3)</sup>	
Stable position	Monostable			Monostable	Bistable	Monostable			
Reset method: pneumatic spring	Yes			Yes	–	No			
Reset method: mechanical spring	No			Yes	–	Yes			
Design	Piston spool								
Sealing principle	Soft								
Type of actuation	Electrical								
Type of pilot control	Piloted								
Pilot air supply port	Internal or external								
Direction of flow	Non-reversible			Reversible with external pilot air supply					
Exhaust air function	Flow control possible, via flow control plate, via individual sub-base								
Manual override	Non-detenting								
Type of mounting	On sub-base								
Mounting position	Any								
Nominal width [mm]	9								
Flow rate of valve [l/min]	1250			1400		1400			
Flow rate of valve on individual sub-base [l/min]	1000			1100		1100			
Flow rate of pneumatically interlinked valve [l/min]	900			1100		1000			
Standard nominal flow rate [l/min]	900			1100		1000			
Switching time on/off, pneumatic spring [ms]	20/33			25/40		–		–	
Switching time on/off, mechanical spring [ms]	–			20/52		–		20/52	
Changeover time, dominant 1st signal [ms]	–			–		15		–	
Changeover time, dominant at 14 [ms]	–			–		25		–	
Non-overlapping	Yes								
Width [mm]	26								
Ports on the sub-base	1, 2, 3, 4, 5			G1/4					
	12, 14			M5					
Tightening torque for valve mounting [Nm]	1.8 ... 2.2								
Product weight [g]	270								
Conforms to standard	ISO 15407-1								

- 1) C=Normally closed
- 2) U = Normally open
- 3) E = Normally exhausted
- 4) H=2x 3/2-way valve in one housing with 1x normally closed and 1x normally open

# Solenoid valves VSVA, with central plug M8x1, M12x1

Technical data – Width 26 mm

**FESTO**

Safety data	
Note on forced switch on/off	Switching frequency min. 1/week
CE marking (see declaration of conformity)	To EU EMC Directive <sup>1)</sup>
Max. positive test pulse with 0 signal	[μs] 500
Max. negative test pulse with 1 signal	[μs] 500
Shock resistance	Shock test with severity level 2 to FN 942017-5 and EN 60068-2-27
Vibration resistance	Transport application test with severity level 2 to FN 942017-4 and EN 60068-2-6

- 1) For information about the applicability of the component see the manufacturer's EC declaration of conformity at: [www.festo.com/sp](http://www.festo.com/sp) → User documentation.  
If the component is subject to restrictions on usage in residential, office or commercial environments or small businesses, further measures to reduce the emitted interference may be necessary.

Operating and environmental conditions				
Valve function		2x3/2-way	5/2-way	5/3-way
Operating medium		Compressed air to ISO 8573-1:2010 [7:4:4]		
Pilot medium		Compressed air to ISO 8573-1:2010 [7:4:4]		
Note on operating/pilot medium		Lubricated operation possible (in which case lubricated operation will always be required)		
Operating pressure	Internal pilot air supply	[bar] 3 ... 8	3 ... 8	3 ... 8
	External pilot air supply	[bar] 3 ... 10	-0.9 ... 16	-0.9 ... 16
Pilot pressure	[bar]	3 ... 8 <sup>1)</sup>	3 ... 8	3 ... 8
Ambient temperature	[°C]	-5 ... +50		
Temperature of medium	[°C]	-5 ... +50		
Corrosion resistance class CRC <sup>2)</sup>		2		
Certification		c CSA us (OL) c UL us - Recognized (OL) C-Tick		

- 1) Pilot pressure dependent on operating pressure → Graph  
2) Corrosion resistance class CRC 2 to Festo standard FN 940070  
Moderate corrosion stress. Indoor applications in which condensation may occur. External visible parts with primarily decorative requirements for the surface and which are in direct contact with the ambient atmosphere typical for industrial applications.

## Minimum pilot pressure p<sub>12</sub>, p<sub>14</sub> as a function of operating pressure p<sub>1</sub> (external pilot air supply) for the 2x 3/2-way solenoid valves

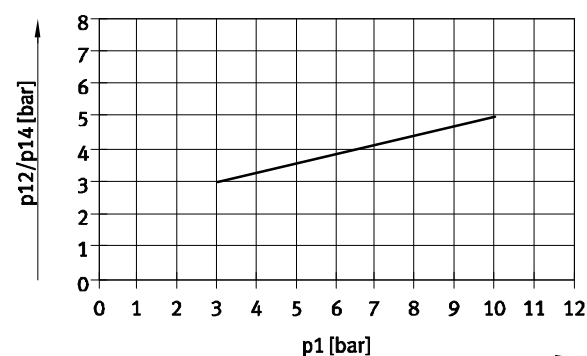

Electrical data			
Electrical connection		Central plug, round design, M8x1 4-pin or M12x1 3-pin	
Characteristic coil data	Voltage	[V DC]	24±10% = 21.6 ... 26.4
	Performance	[W]	High-current phase: 2.4 ; Low-current phase: 1 <sup>1)</sup>
Nominal pick-up current per solenoid coil	[mA]	110 to 20 ms	
Nominal current with current reduction	[mA]	30 after 20 ms	
Duty cycle	%	100	
Degree of protection to EN 60529		IP65, Nema 4 (in combination with plug socket)	
Protective circuit and LED		Integrated in the valve	

- 1) Controlled by integrated current reduction

# Solenoid valves VSVA, with central plug M8x1, M12x1

Technical data – Width 26 mm

## Materials

Sectional view

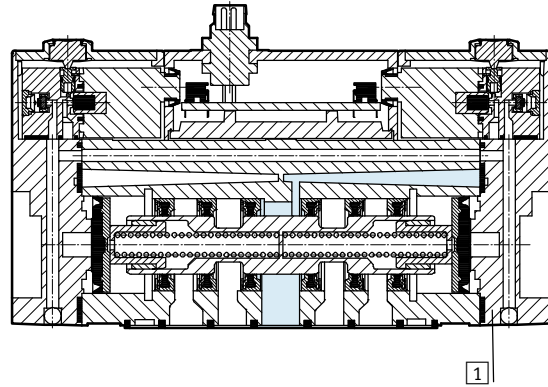
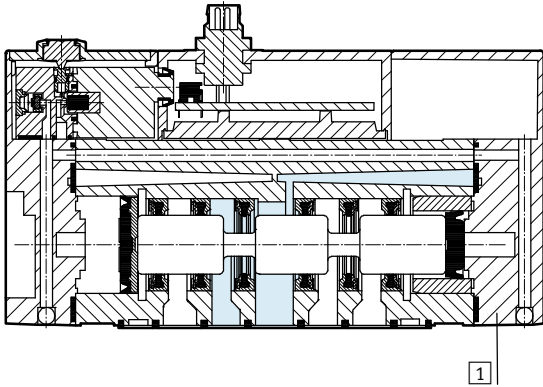

1	Housing	Die-cast aluminium, POM
-	Seals	HNBR, NBR, FPM
-	Note on materials	RoHS compliant

## Dimensions

Download CAD data → [www.festo.com](http://www.festo.com)

Valve with central plug M8x1, VSVA-B...-1R2L

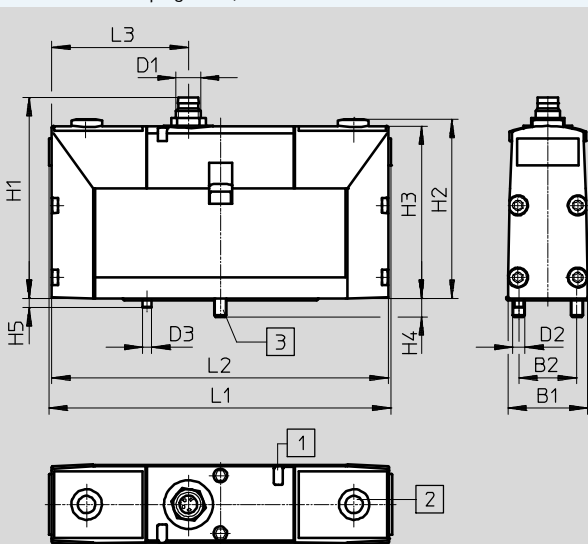

- 1 Light-emitting diode (LED)
- 2 Manual override
- 3 Captive mounting screws

Valve with central plug M12x1, VSVA-B...-1R5L

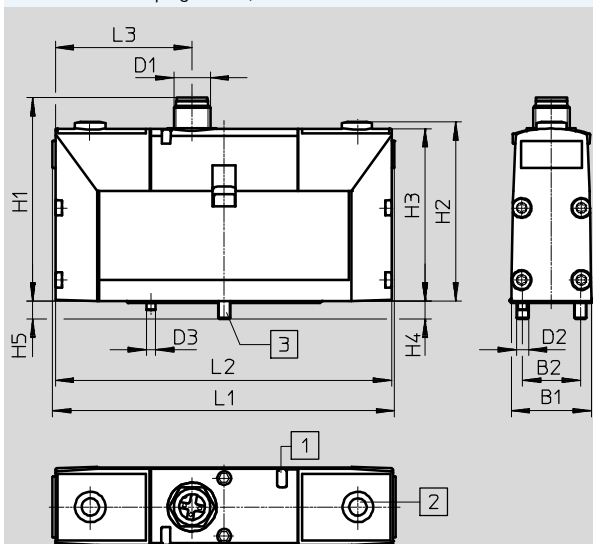

- 1 Light-emitting diode (LED)
- 2 Manual override
- 3 Captive mounting screws

Type	B1	B2	D1	D2	D3	H1	H2	H3	H4	H5	L1	L2	L3
VSVA-B...-1R2L	26.3	19	M8x1	M4	3	63.3	59.2	56.6	6	3	112.5	110.7	46.5
VSVA-B...-1R5L			M12x1			66.6							

## Pin allocation

M8x1

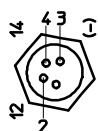

- 1 Unused
- 2 Signal (+) solenoid 12/10
- 3 com (-)
- 4 Signal (+) Solenoid 14/10

M12x1

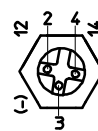

- 1 Unused
- 2 Signal (+) Solenoid 12
- 3 com (-)
- 4 Signal (+) Solenoid 14

# Solenoid valves VSVA, with central plug M8x1, M12x1

Technical data – Width 26 mm

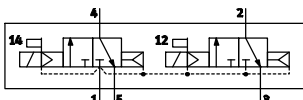
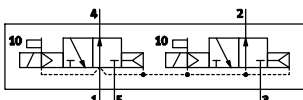
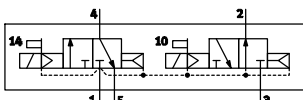
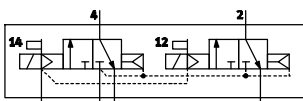
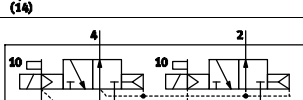
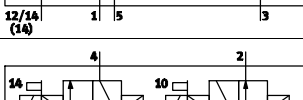
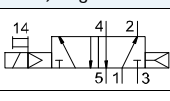
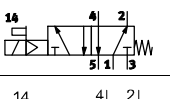
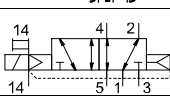
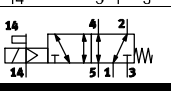
Ordering data						
Code	Circuit symbol			Part No.	Type	
<b>2x 3/2-way solenoid valve</b>						
K		Normal position: 2x closed	Internal pilot air supply	M8x1	534532	VSVA-B-T32C-AH-A1-1R2L
				M12x1	534552	VSVA-B-T32C-AH-A1-1R5L
N		Normal position: 2x open	Internal pilot air supply	M8x1	534533	VSVA-B-T32U-AH-A1-1R2L
				M12x1	534553	VSVA-B-T32U-AH-A1-1R5L
H		Normal position: 1x closed 1x open	Internal pilot air supply	M8x1	534534	VSVA-B-T32H-AH-A1-1R2L
				M12x1	534554	VSVA-B-T32H-AH-A1-1R5L
K		Normal position: 2x closed	External pilot air supply	M8x1	534522	VSVA-B-T32C-AZH-A1-1R2L
				M12x1	534542	VSVA-B-T32C-AZH-A1-1R5L
N		Normal position: 2x open	External pilot air supply	M8x1	534523	VSVA-B-T32U-AZH-A1-1R2L
				M12x1	534543	VSVA-B-T32U-AZH-A1-1R5L
H		Normal position: 1x closed 1x open	External pilot air supply	M8x1	534524	VSVA-B-T32H-AZH-A1-1R2L
				M12x1	534544	VSVA-B-T32H-AZH-A1-1R5L
<b>5/2-way valve, single solenoid</b>						
M		Pneumatic spring	Internal pilot air supply	M8x1	534535	VSVA-B-M52-AH-A1-1R2L
				M12x1	534555	VSVA-B-M52-AH-A1-1R5L
O		Mechanical spring	Internal pilot air supply	M8x1	534536	VSVA-B-M52-MH-A1-1R2L
				M12x1	534556	VSVA-B-M52-MH-A1-1R5L
M		Pneumatic spring	External pilot air supply	M8x1	534525	VSVA-B-M52-AZH-A1-1R2L
				M12x1	534545	VSVA-B-M52-AZH-A1-1R5L
O		Mechanical spring	External pilot air supply	M8x1	534526	VSVA-B-M52-MZH-A1-1R2L
				M12x1	534546	VSVA-B-M52-MZH-A1-1R5L



# Solenoid valves VSVA, with central plug M8x1, M12x1

Technical data – Width 26 mm

Ordering data						
Code	Circuit symbol				Part No.	Type
<b>5/2-way valve, double solenoid</b>						
J		Dominant 1st signal	Internal pilot air supply	M8x1	534537	VSVA-B-B52-H-A1-1R2L
				M12x1	534557	VSVA-B-B52-H-A1-1R5L
D		Dominant at 14	Internal pilot air supply	M8x1	534538	VSVA-B-D52-H-A1-1R2L
				M12x1	534558	VSVA-B-D52-H-A1-1R5L
J		Dominant 1st signal	External pilot air supply	M8x1	534527	VSVA-B-B52-ZH-A1-1R2L
				M12x1	534547	VSVA-B-B52-ZH-A1-1R5L
D		Dominant at 14	External pilot air supply	M8x1	534528	VSVA-B-D52-ZH-A1-1R2L
				M12x1	534548	VSVA-B-D52-ZH-A1-1R5L
<b>5/3-way valve</b>						
G		Normally closed	Internal pilot air supply	M8x1	534539	VSVA-B-P53C-H-A1-1R2L
				M12x1	534559	VSVA-B-P53C-H-A1-1R5L
B		Normally open	Internal pilot air supply	M8x1	534541	VSVA-B-P53U-H-A1-1R2L
				M12x1	534561	VSVA-B-P53U-H-A1-1R5L
E		Normally exhausted	Internal pilot air supply	M8x1	534540	VSVA-B-P53E-H-A1-1R2L
				M12x1	534560	VSVA-B-P53E-H-A1-1R5L
G		Normally closed	External pilot air supply	M8x1	534529	VSVA-B-P53C-ZH-A1-1R2L
				M12x1	534549	VSVA-B-P53C-ZH-A1-1R5L
B		Normally open	External pilot air supply	M8x1	534531	VSVA-B-P53U-ZH-A1-1R2L
				M12x1	534551	VSVA-B-P53U-ZH-A1-1R5L
E		Normally exhausted	External pilot air supply	M8x1	534530	VSVA-B-P53E-ZH-A1-1R2L
				M12x1	534550	VSVA-B-P53E-ZH-A1-1R5L

# Pneumatic valves VSPA, ISO 15407-1

FESTO

Technical data – Width 18 mm

Flow rate  
550 ... 750 l/min



General technical data					
Valve function	2x 3/2-way		5/2-way		5/3-way
Normal position	C <sup>1)</sup> , U <sup>2)</sup> , H <sup>4)</sup>		–		C <sup>1)</sup> , U <sup>2)</sup> , E <sup>3)</sup>
Stable position	Monostable		Monostable	Bistable	Monostable
Reset method: pneumatic spring	Yes		Yes	–	No
Reset method: mechanical spring	No		Yes	–	Yes
Design	Piston spool				
Sealing principle	Soft				
Type of actuation	Pneumatic				
Type of pilot control	Direct				
Direction of flow	Non-reversible	Reversible	Reversible	Reversible	Reversible
Exhaust function	With flow control				
Type of mounting	On sub-base				
Mounting position	Any				
Nominal width [mm]	5				
Flow rate of valve [l/min]	600	750	750	750	650
Flow rate of valve on individual sub-base [l/min]	450	550	550	550	500
Flow rate of pneumatically interlinked valve [l/min]	400	550	550	550	450
Standard nominal flow rate [l/min]	400	550	550	550	450
Switching time on/off, pneumatic spring [ms]	10/15	11/20	–	–	–
Switching time on/off, mechanical spring [ms]	–	8/18	–	–	9/18
Changeover time [ms]	–	–	6	6	–
Changeover time (dominant) [ms]	–	–	6	6	–
Non-overlapping	Yes				
Width [mm]	18				
Ports on the sub-base	1, 2, 3, 4, 5	G1/8			
	12, 14	M5			
Tightening torque for valve mounting [Nm]	0.9 ... 1.1				
Product weight [g]	80				
Conforms to standard	ISO 15407-1, VDMA 24563				

- 1) C=Normally closed  
 2) U = Normally open  
 3) E = Normally exhausted  
 4) H=2x3/2-way valve in one housing with 1x normally closed and 1x normally open

Operating and environmental conditions					
Valve function	2x3/2-way	5/2-way, monostable		5/2-way, bistable	5/3-way
		Pneumatic spring	Mechanical spring		
Operating medium	Compressed air to ISO 8573-1:2010 [7:4:4]				
Pilot medium	Compressed air to ISO 8573-1:2010 [7:4:4]				
Note on operating/pilot medium	Lubricated operation possible (in which case lubricated operation will always be required)				
Operating pressure [bar]	2 ... 10	2 ... 10	–0.9 ... 10	–0.9 ... 10	–0.9 ... 10
Pilot pressure [bar]	2 ... 10	2 ... 10	3 ... 10	2 ... 10	3 ... 10
Ambient temperature [°C]	–10 ... +60				
Temperature of medium [°C]	–10 ... +60				

# Pneumatic valves VSPA, to ISO 15407-1

Technical data – Width 18 mm

Safety data	
Note on forced switch on/off	Switching frequency min. 1/week

## Materials

Sectional view

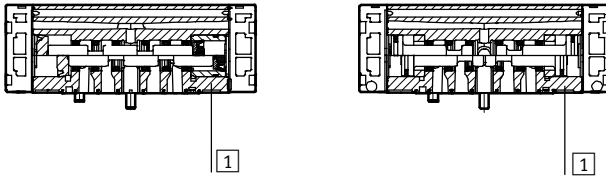

1	Housing	Die-cast aluminium
-	Seals	NBR
-	Screws	Galvanised steel
-	Note on materials	RoHS compliant

## Dimensions

Download CAD data → [www.festo.com](http://www.festo.com)

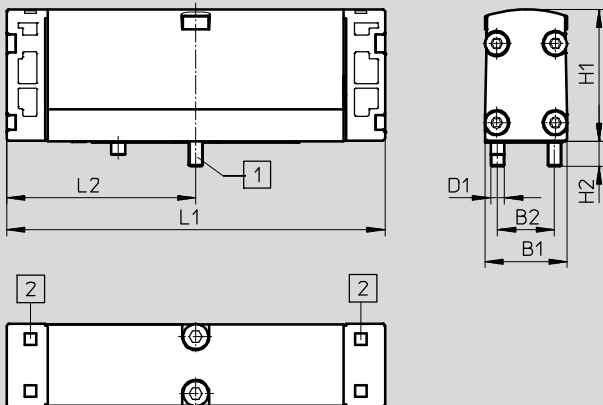



- 1 Captive screws      2 Slot for inscription label

	B1	B2	D1	H1	H2	L1	L2
VSPA-B	18	12.5	M3	29	5.4	83	41.5

# Pneumatic valves VSPA, ISO 15407-1

Technical data – Width 18 mm

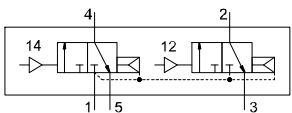
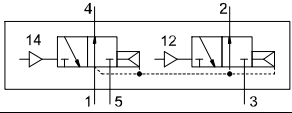
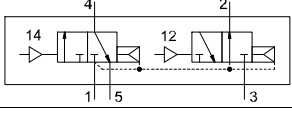
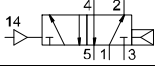
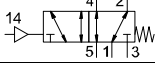
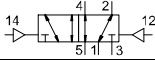
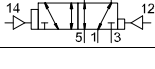
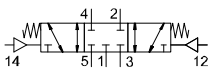
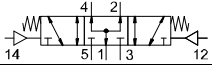
**FESTO**

Ordering data				
Code	Circuit symbol		Part No.	Type
<b>2x 3/2-way pneumatic valve</b>				
K		2x normally closed	546721	VSPA-B-T32C-A2
N		2x normally open	546722	VSPA-B-T32U-A2
H		Normal position: 1x closed 1x open	546723	VSPA-B-T32H-A2
<b>5/2-way pneumatic valve, monostable</b>				
M		Pneumatic spring	546726	VSPA-B-M52-A-A2
O		Mechanical spring	546727	VSPA-B-M52-M-A2
<b>5/2-way pneumatic valve, bistable</b>				
J		Dominant 1st signal	546724	VSPA-B-B52-A2
D		Dominant at 14	546725	VSPA-B-D52-A2
<b>5/3-way pneumatic valve</b>				
G		Normally closed	546730	VSPA-B-P53C-A2
B		Normally open	546728	VSPA-B-P53U-A2
E		Normally exhausted	546729	VSPA-B-P53E-A2

# Pneumatic valves VSPA, ISO 15407-1

Technical data – Width 26 mm

 Flow rate  
 1250 ... 1400 l/min



General technical data					
Valve function	2x 3/2-way		5/2-way		5/3-way
Normal position	C <sup>1)</sup> , U <sup>2)</sup> , H <sup>4)</sup>		–	–	C <sup>1)</sup> , U <sup>2)</sup> , E <sup>3)</sup>
Stable position	Monostable		Monostable	Bistable	Monostable
Reset method: pneumatic spring	Yes		Yes	–	No
Reset method: mechanical spring	No		Yes	–	Yes
Design	Piston spool				
Sealing principle	Soft				
Type of actuation	Pneumatic				
Type of pilot control	Direct				
Direction of flow	Non-reversible		Reversible	Reversible	Reversible
Exhaust function	With flow control				
Type of mounting	On sub-base				
Mounting position	Any				
Nominal width [mm]	9				
Flow rate of valve [l/min]	1250	1400	1400	1400	1400
Flow rate of valve on individual sub-base [l/min]	1000	1100	1100	1100	1100
Flow rate of pneumatically interlinked valve [l/min]	900	1100	1100	1100	1000
Standard nominal flow rate [l/min]	900	1100	1100	1100	1000
Switching time on/off, pneumatic spring [ms]	15/28	18/30	–	–	–
Switching time on/off, mechanical spring [ms]	–	10/35	–	–	13/32
Changeover time [ms]	–	–	10	–	–
Changeover time (dominant) [ms]	–	–	10	–	–
Non-overlapping	Yes				
Width [mm]	26				
Ports on the sub-base	1, 2, 3, 4, 5	G1/4			
	12, 14	M5			
Tightening torque for valve mounting [Nm]	1.8 ... 2.2				
Product weight [g]	180				
Conforms to standard	ISO 15407-1, VDMA 24563				

- 1) C = Normally closed
- 2) U = Normally open
- 3) E = Normally exhausted
- 4) H = 2x3/2-way valve in one housing with 1x normally closed and 1x normally open

Operating and environmental conditions					
Valve function	2x3/2-way	5/2-way, monostable		5/2-way, monostable	5/3-way
		Pneumatic spring	Mechanical spring		
Operating medium	Compressed air to ISO 8573-1:2010 [7:4:4]				
Pilot medium	Compressed air to ISO 8573-1:2010 [7:4:4]				
Note on operating/pilot medium	Lubricated operation possible (in which case lubricated operation will always be required)				
Operating pressure [bar]	2 ... 10	2 ... 10	–0.9 ... 16	–0.9 ... 16	–0.9 ... 16
Pilot pressure [bar]	2 ... 10	2 ... 10	3 ... 10	2 ... 10	3 ... 10
Ambient temperature [°C]	–10 ... +60				
Temperature of medium [°C]	–10 ... +60				

# Pneumatic valves VSPA, to ISO 15407-1

Technical data – Width 26 mm

**FESTO**

## Safety data

Note on forced switch on/off      Switching frequency min. 1/week

## Materials

Sectional view

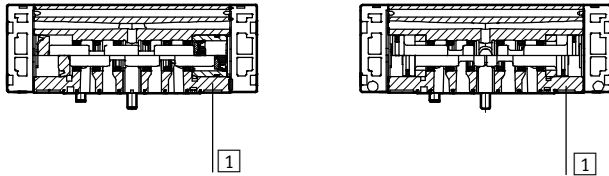

1	Housing	Die-cast aluminium
-	Seals	NBR
-	Screws	Galvanised steel
-	Note on materials	RoHS compliant

## Dimensions

Download CAD data → [www.festo.com](http://www.festo.com)

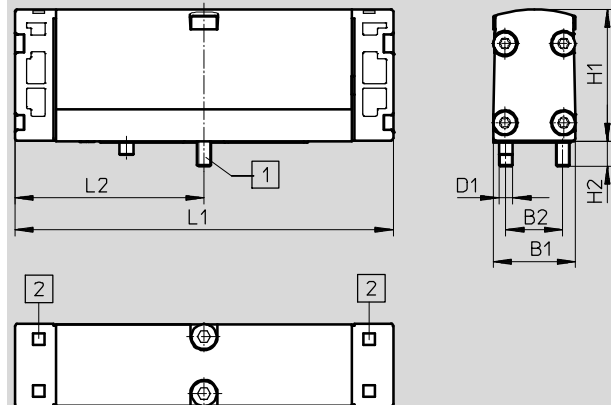

1 Captive screws      2 Slot for inscription label

	B1	B2	D1	H1	H2	L1	L2
VSPA-B	26.2	19	M4	38	7	100	50

# Pneumatic valves VSPA, to ISO 15407-1

Technical data – Width 26 mm

Ordering data				
Code	Circuit symbol		Part No.	Type
<b>2x 3/2-way pneumatic valve</b>				
K		2x normally closed	546711	VSPA-B-T32C-A1
N		2x normally open	546712	VSPA-B-T32U-A1
H		Normal position: 1x closed 1x open	546713	VSPA-B-T32H-A1
<b>5/2-way pneumatic valve, monostable</b>				
M		Pneumatic spring	546716	VSPA-B-M52-A-A1
O		Mechanical spring	546717	VSPA-B-M52-M-A1
<b>5/2-way pneumatic valve, bistable</b>				
J		Dominant 1st signal	546714	VSPA-B-B52-A1
D		Dominant at 14	546715	VSPA-B-D52-A1
<b>5/3-way pneumatic valve</b>				
G		Normally closed	546720	VSPA-B-P53C-A1
B		Normally open	546718	VSPA-B-P53U-A1
E		Normally exhausted	546719	VSPA-B-P53E-A1

# Manifold components, ISO 15407-1

Vertical stacking



## Regulator plate

VABF-S3-2-R

VABF-S3-1-R

Pressure regulation ranges:

0.5 ... 6 bar, 0.5 ... 10 bar

Output pressure constant with secondary venting

- - Temperature range  
-5 ... +50 °C

- - Input pressure  
0.5 ... 10 bar

Materials:

Housing: Die-cast aluminium

Control section: PA

Note on materials:

RoHS compliant

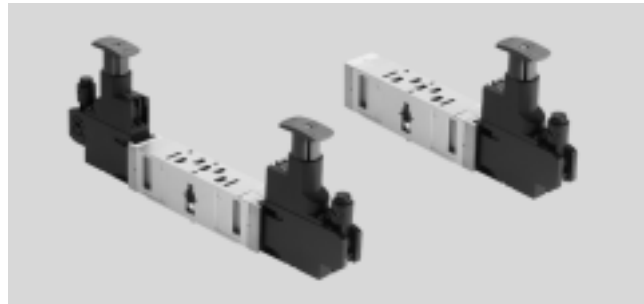

Operating and environmental conditions	
Operating medium	Compressed air to ISO 8573-1:2010 [7:4:4]
Note on operating/pilot medium	Lubricated operation possible (in which case lubricated operation will always be required)

### Dimensions

Download CAD data → [www.festo.com](http://www.festo.com)

- 1 Captive screws
- 2 Port pattern to ISO 15407-1
- 3 Regulator
- 4 Pressure gauge
- 5 Regulator head in the locked state
- 6 Regulator head with pressure adjustment

Dimensions when mounted → 67

Type	B1	B2	H1	H2	H3	H4	L1	L2	L3	L4	L5	L6	L7	L8
VABF-S3-2-R1	18	35	110	97	77.3	5.6	126.7	180.6	-	-	-	-	39.8	2.9
VABF-S3-2-R2							126.7	-	187.7	-	-	-		
VABF-S3-2-R3							-	-	-	-	126.7	187.7		
VABF-S3-2-R4							126.7	-	-	253.4	-	-		
VABF-S3-2-R5							126.7	-	-	253.4	-	-		
VABF-S3-2-R6							126.7	-	187.7	-	-	-		
VABF-S3-2-R7							-	-	-	-	126.7	187.7		
VABF-S3-1-R1	26	35	110	97	77.3	5.6	130.4	183.9	183.9	-	-	-	39.8	2.9
VABF-S3-1-R2							130.4	-	192.9	-	-	-		
VABF-S3-1-R3							-	-	-	-	130.4	192.9		
VABF-S3-1-R4							130.4	-	-	260.7	-	-		
VABF-S3-1-R5							130.4	-	-	260.7	-	-		
VABF-S3-1-R6							130.4	195	195	-	-	-		
VABF-S3-1-R7							-	-	-	-	130.4	192.9		



# Manifold components, ISO 15407-1

Vertical stacking

Ordering data								
Code	Circuit symbol	For port	Control- ler	Control range	Width [mm]	Weight [g]	Part No.	Type
ZA		1	P	0.5 ... 10 bar	18	380	543526	VABF-S3-2-R1C2-C-10
					26	439	543527	VABF-S3-1-R1C2-C-10
ZF		1	P	0.5 ... 6 bar	18	380	543524	VABF-S3-2-R1C2-C-6
					26	439	543525	VABF-S3-1-R1C2-C-6
ZC		2	B	0.5 ... 10 bar	18	390	543534	VABF-S3-2-R2C2-C-10
					26	452	543535	VABF-S3-1-R2C2-C-10
ZH		2	B	0.5 ... 6 bar	18	390	543532	VABF-S3-2-R2C2-C-6
					26	452	543533	VABF-S3-1-R2C2-C-6
ZB		4	A	0.5 ... 10 bar	18	390	543530	VABF-S3-2-R3C2-C-10
					26	452	543531	VABF-S3-1-R3C2-C-10
ZG		4	A	0.5 ... 6 bar	18	390	543528	VABF-S3-2-R3C2-C-6
					26	452	543529	VABF-S3-1-R3C2-C-6
ZD		2 and 4	AB	0.5 ... 10 bar	18	650	543538	VABF-S3-2-R4C2-C-10
					26	712	543539	VABF-S3-1-R4C2-C-10
ZI		2 and 4	AB	0.5 ... 6 bar	18	650	543536	VABF-S3-2-R4C2-C-6
					26	712	543537	VABF-S3-1-R4C2-C-6
ZE		2 and 4, reversible	AB	0.5 ... 10 bar	18	650	543542	VABF-S3-2-R5C2-C-10
					26	712	543543	VABF-S3-1-R5C2-C-10
ZJ		2 and 4, reversible	AB	0.5 ... 6 bar	18	650	543540	VABF-S3-2-R5C2-C-6
					26	712	543541	VABF-S3-1-R5C2-C-6
ZL		2, reversible	B	0.5 ... 10 bar	18	390	546788	VABF-S3-2-R6C2-C-10
					26	452	546789	VABF-S3-1-R6C2-C-10
ZN		2, reversible	B	0.5 ... 6 bar	18	390	546786	VABF-S3-2-R6C2-C-6
					26	452	546787	VABF-S3-1-R6C2-C-6
ZK		4, reversible	A	0.5 ... 10 bar	18	390	546792	VABF-S3-2-R7C2-C-10
					26	452	546793	VABF-S3-1-R7C2-C-10
ZM		4, reversible	A	0.5 ... 6 bar	18	390	546790	VABF-S3-2-R7C2-C-6
					26	452	546791	VABF-S3-1-R7C2-C-6

# Manifold components, ISO 15407-1

Vertical stacking

FESTO

## Flow control plate

VABF-S3-2-F

VABF-S3-1-F

Materials:

Housing: Die-cast aluminium

Note on materials:

RoHS compliant

-  - Temperature range  
-5 ... +50 °C

-  - Input pressure  
-0.9 ... 10 bar

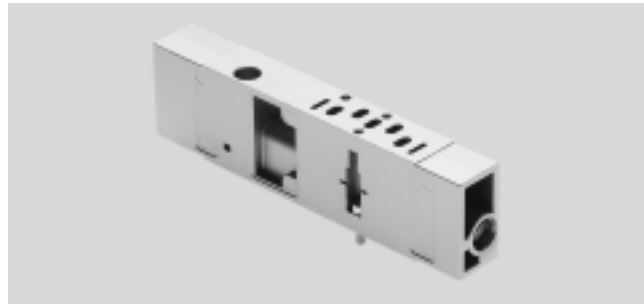

## Operating and environmental conditions

Operating medium	Compressed air to ISO 8573-1:2010 [7:4:4]
Note on operating/pilot medium	Lubricated operation possible (in which case lubricated operation will always be required)

## Dimensions

Download CAD data → [www.festo.com](http://www.festo.com)

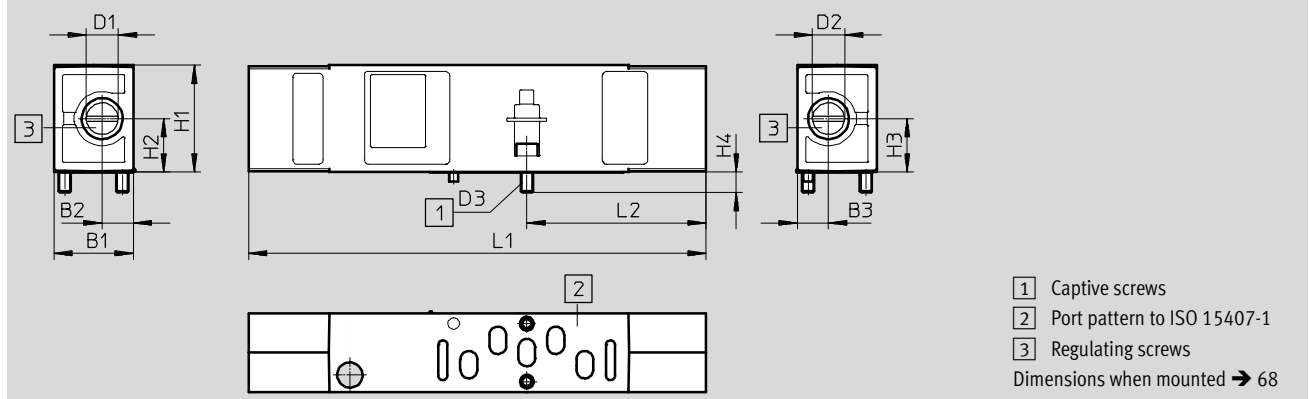

Type	B1	B2	B3	D1	D2	D3	H1	H2	H3	H4	L1	L2
VABF-S3-2-F1B1-C	18	6.5	6.5	9.3	9.3	M3x 12	35	12	12	5.6	130	43.3
VABF-S3-1-F1B1-C	26	10.2	10.2	11.2	11.2	M4x 12	35	17.5	17.5	6.7	150	58.8

## Ordering data

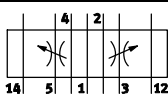
Code	Circuit symbol	Description	Width [mm]	Weight [g]	Part No.	Type
X		For exhaust air flow control in ducts 3 and 5 on the valve	18	228	<b>543603</b>	<b>VABF-S3-2-F1B1-C</b>
			26	320	<b>543604</b>	<b>VABF-S3-1-F1B1-C</b>

# Manifold components, ISO 15407-1

Vertical stacking



**Vertical supply plate**

**VABF-S3-2-P**

**VABF-S3-1-P**

Materials:  
Housing: Die-cast aluminium

Note on materials:  
RoHS compliant

-  - Temperature range  
-5 ... +50 °C
-  - Operating pressure  
-0.9 ... +10 bar



Operating and environmental conditions	
Operating medium	Compressed air to ISO 8573-1:2010 [7:4:4]
Note on operating/pilot medium	Lubricated operation possible (in which case lubricated operation will always be required)

**Dimensions** Download CAD data → [www.festo.com](http://www.festo.com)

1 Captive screws  
2 Port pattern to ISO 15407-1  
 Dimensions when mounted → 69

Type	B1	B2	D1	D2	H1	H2	H3	L1	L2
VABF-S3-2-P1A3-G18	18	9	G $\frac{1}{8}$	M3x 12	35	23.4	5.6	121.6	67.7
VABF-S3-1-P1A3-G14	26	13	G $\frac{1}{4}$	M4x 12	35	23.2	6.7	128.1	74.6

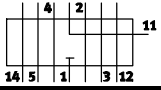
Ordering data							
Code	Circuit symbol	Description	Width [mm]	Flow rates [l/min]	Weight [g]	Part No.	Type
ZU		For the independent supply of a valve	18	500	146	<b>544435</b>	<b>VABF-S3-2-P1A3-G18</b>
			26	1000	201	<b>544434</b>	<b>VABF-S3-1-P1A3-G14</b>

# Manifold components, ISO 15407-1

Vertical stacking



## Vertical pressure shut-off plate

VABF-S3-2-L

VABF-S3-1-L

Materials:

Housing: Die-cast aluminium

Note on materials:

RoHS compliant

- - Temperature range  
-5 ... +50 °C
- - Input pressure  
-0.9 ... +10 bar
- - Flow rate  
800 l/min

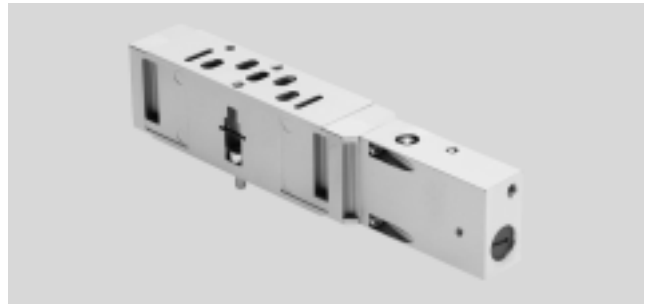

Operating and environmental conditions	
Operating medium	Compressed air to ISO 8573-1:2010 [7:4:4]
Note on operating/pilot medium	Lubricated operation possible (in which case lubricated operation will always be required)

### Dimensions

Download CAD data → [www.festo.com](http://www.festo.com)

- 1 Captive screws
- 2 Port pattern to ISO 15407-1
- 3 Plug screw

Dimensions when mounted → 70

Type	B1	B2	B3	D1	D2	H1	H2	H3	H4	L1	L2
VABF-S3-2-L1D1-C	18	9	5.1	M5	M3x 12	35	11.7	5.6	5.3	163.7	109.8
VABF-S3-1-L1D1-C	26	13	9.1	M5	M4x 12	35	11.6	6.7	5.3	167	113.4

Ordering data							
Code	Circuit symbol	Description	Width [mm]	Flow rates [l/min]	Weight [g]	Part No.	Type
ZT		For shutting off a valve from the supply pressure	18	400	212	<b>543601</b>	<b>VABF-S3-2-L1D1-C</b>
			26	800	286	<b>543602</b>	<b>VABF-S3-1-L1D1-C</b>

# Manifold components, ISO 15407-1

Individual linking

Individual sub-base NAS

Materials:  
Die-cast aluminium



Operating and environmental conditions	
Operating medium	Compressed air to ISO 8573-1:2010 [7:4:4]
Note on operating/pilot medium	Lubricated operation possible (in which case lubricated operation will always be required)

**Dimensions** Download CAD data → [www.festo.com](http://www.festo.com)

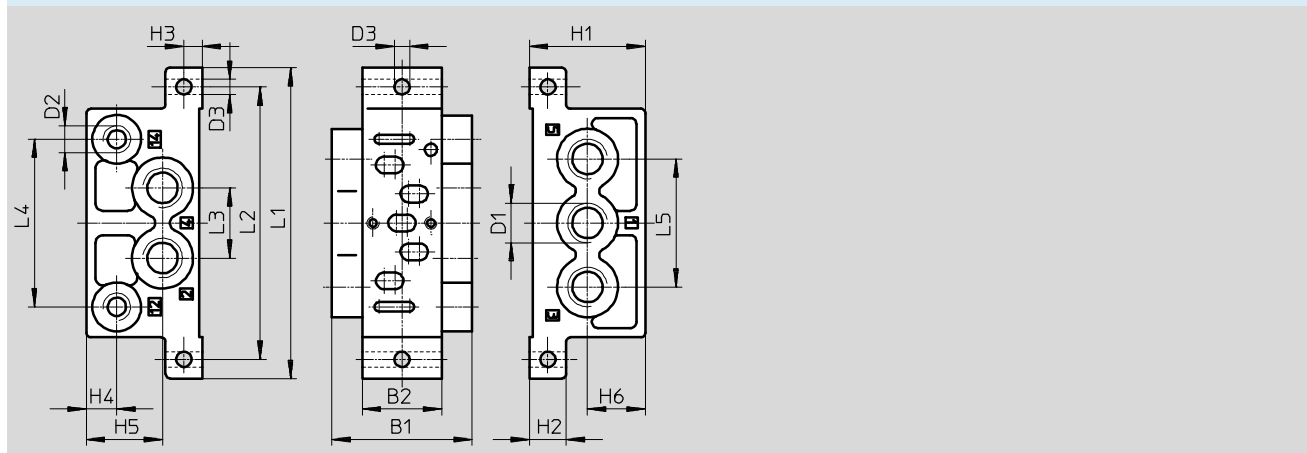

Type	B1	B2	D1	D2	D3	H1	H2	H3	H4	H5	H6	L1	L2	L3	L4	L5
NAS-1/8-02-VDMA	28.5	18	G1/8	M5	5.5	31	10	5	7	20	14.5	79	66.5	17	40	32
NAS-1/4-01-VDMA	46	26	G1/4	G1/8	5	38	12	6	10	25	19	102	89.4	23	55	42

Ordering data						
Type of mounting	Width [mm]	Pneumatic port		Weight [g]	Part No.	Type
		1, 2, 3, 4, 5	12, 14			
2 through-holes in the housing	18	G1/8	M5	67	<b>161115</b>	<b>NAS-1/8-02-VDMA</b>
	26	G1/4	G1/8	160	<b>161109</b>	<b>NAS-1/4-01-VDMA</b>

# Manifold components, ISO 15407-1

Horizontal stacking

FESTO

## Manifold sub-base NAW

Materials:  
Die-cast aluminium



Operating and environmental conditions	
Operating medium	Compressed air to ISO 8573-1:2010 [7:4:4]
Note on operating/pilot medium	Lubricated operation possible (in which case lubricated operation will always be required)

Ordering data						
Manifold sub-base	Widths [mm]	Pneumatic port		Weight [g]	Part No.	Type
		2, 4	12, 14			
For solenoid valves	18	G $\frac{1}{8}$	–	130	161110	NAW- $\frac{1}{8}$ -02-VDMA
	26	G $\frac{1}{4}$	–	225	161102	NAW- $\frac{1}{4}$ -01-VDMA
For pneumatic valves	18	G $\frac{1}{8}$	M5	130	161111	NAW- $\frac{1}{8}$ -02-VDMA-VL
	26	G $\frac{1}{4}$	M5	225	161103	NAW- $\frac{1}{4}$ -01-VDMA-VL

Dimensions → 64

## End plate kit NEV

Materials:  
Die-cast aluminium

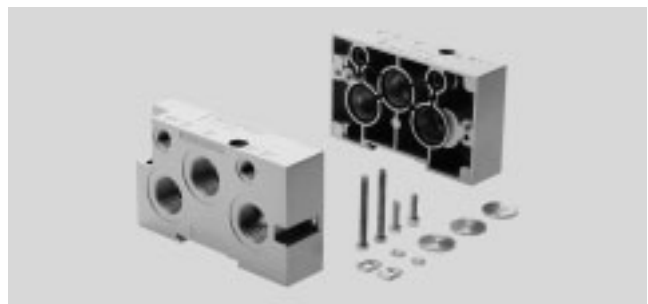

Operating and environmental conditions	
Operating medium	Compressed air to ISO 8573-1:2010 [7:4:4]
Note on operating/pilot medium	Lubricated operation possible (in which case lubricated operation will always be required)

Ordering data						
Scope of delivery	Width [mm]	Pneumatic port		Weight [g]	Part No.	Type
		1, 3, 5	12, 14			
End plate left and right, screws, H-rail mounting, one isolating disc each for ports 1, 3, 5, 12 and 14	18	G $\frac{3}{8}$	G $\frac{1}{8}$	280	161112	NEV-02-VDMA
	26	G $\frac{1}{2}$	G $\frac{1}{8}$	445	161104	NEV-01-VDMA
End plate left 18 mm and right 26 mm, screws, H-rail mounting	18, 26	G $\frac{3}{8}$ , G $\frac{1}{2}$	G $\frac{1}{8}$	372	191405	NEV-02-01-VDMA

Dimensions → 64

# Manifold components, ISO 15407-1

Horizontal stacking

## Intermediate plate NZV

For combi manifold with widths of 18 mm and 26 mm

Materials:  
Die-cast aluminium



Operating and environmental conditions	
Operating medium	Compressed air to ISO 8573-1:2010 [7:4:4]
Note on operating/pilot medium	Lubricated operation possible (in which case lubricated operation will always be required)

## Dimensions Download CAD data → [www.festo.com](http://www.festo.com)

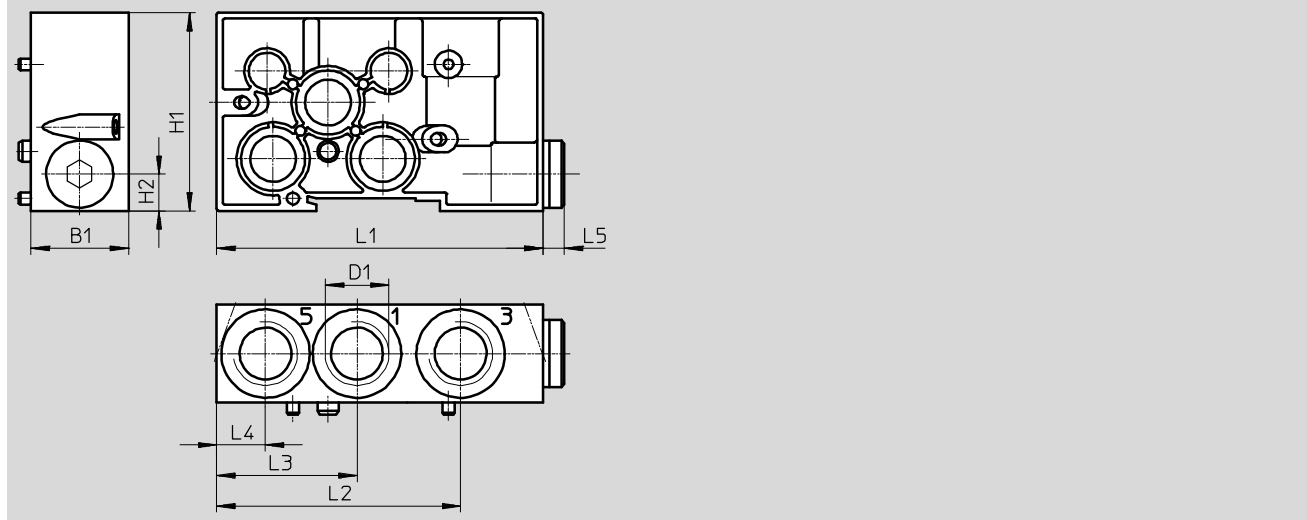

Type	B1	D1	H1	H2	L1	L2	L3	L4	L5
NZV-01/02-VDMA	32	G1/2	65	12	107	80	46	16	7

Ordering data						
Description	Width [mm]	Pneumatic port		Weight [g]	Part No.	Type
		1, 3, 5	12, 14			
Intermediate plate to combine manifold sub-bases of widths 18 mm and 26 mm	18 and 26	G1/2	–	270	<b>161108</b>	<b>NZV-01/02-VDMA</b>

# Manifold components, ISO 15407-1

Technical data

**FESTO**

## Dimensions – Manifold sub-bases without valves

Download CAD data → [www.festo.com](http://www.festo.com)

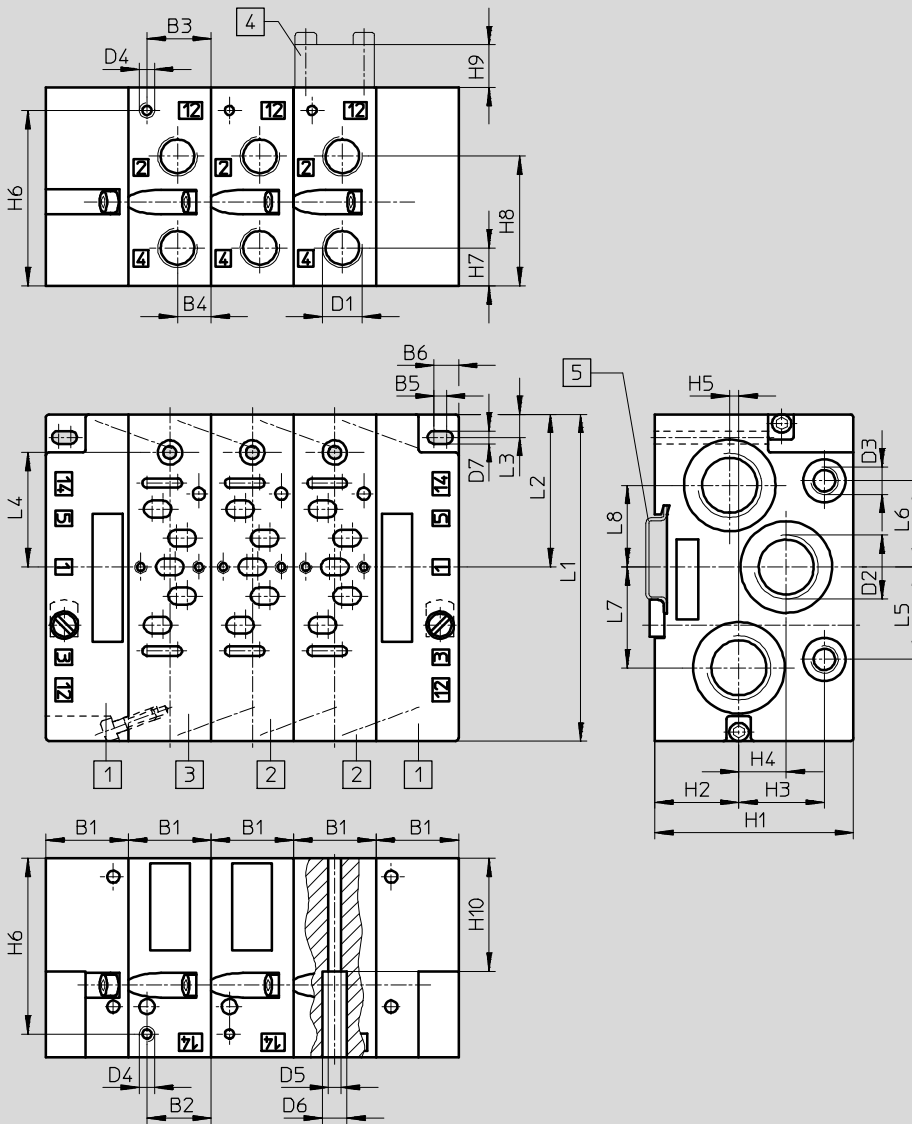

- 1 End plate kit  
NEV...VDMA  
→ 62
- 2 Manifold sub-base  
NAW...VDMA  
→ 62
- 3 Manifold sub-base  
NAW...VDMA-VL  
→ 62
- 4 Cover plate  
NDV...VDMA  
→ 71
- 5 DIN mounting rail  
NRH-35-2000  
→ [www.festo.com](http://www.festo.com)

Width [mm]	B1	B2	B3	B4	B5	B6	D1	D2	D3	D4	D5	D6	D7
18	19	6	13	7.5	1	4.5	G <sup>1</sup> / <sub>8</sub>	G <sup>3</sup> / <sub>8</sub>	G <sup>1</sup> / <sub>8</sub>	M5	3.3	6.3	4.3
26	27	21	21	11	4	8	G <sup>1</sup> / <sub>4</sub>	G <sup>1</sup> / <sub>2</sub>	G <sup>1</sup> / <sub>8</sub>	M5	4.2	8	4.2

Width [mm]	H1	H2	H3	H4	H5	H6	H7	H8	H9	H10	L1	L2	L3	L4	L5	L6	L7	L8
18	55	17	28.8	18.5	–	48	10.5	35.5	12	40	81	36.5	5.6	30.9	20	20	18	18
26	65	27.5	28	15.5	3	57.5	12.5	42.5	14	37	107	50	7.5	37.5	30.3	28.3	33	26.8



# Manifold components, ISO 15407-1

Technical data

FESTO

Dimensions – Manifold assembly, width 18 mm

Download CAD data → [www.festo.com](http://www.festo.com)

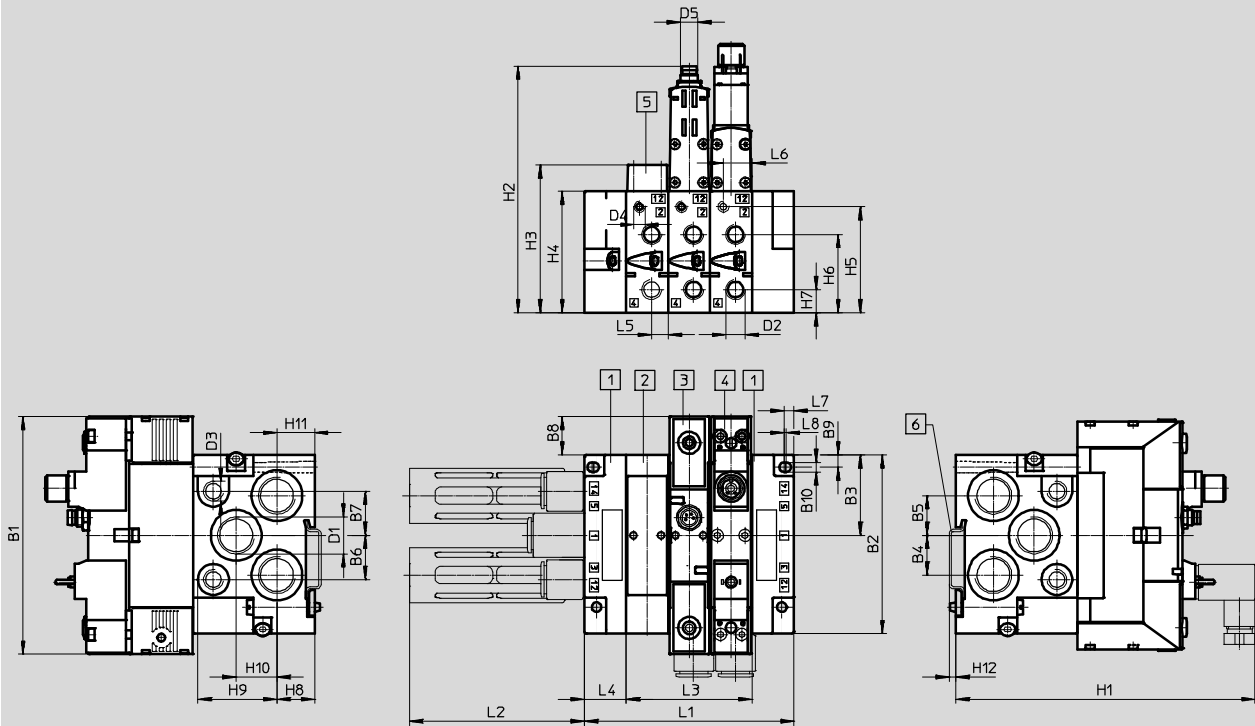

- 1 End plate kit type NEV-02-VDMA
- 2 Manifold sub-bases type NAW-1/8-02-VDMA
- 3 Solenoid valve with central plug
- 4 Solenoid valve with pilot interface to ISO 15218
- 5 Blanking plate NDV-02-VDMA
- 6 Mounting rail NRH-35-2000
- 7 Solenoid valve with central plug
- 8 Solenoid valve with pilot interface to ISO 15218

	B1	B2	B3	B4	B5	B6	B7	B8	B9	B10	D1	D2	D3	D4	D5	H1	H2	H3
VSVA-B-...A2	107.8	81	36.5	18	18	20	20	17.4	5.6	4.3	G $\frac{3}{8}$	G $\frac{1}{8}$	G $\frac{1}{8}$	M5	-	135.6	55	67
VSVA-B-M52-...A2	95.4	81	36.5	18	18	20	20	5	5.6	4.3	G $\frac{3}{8}$	G $\frac{1}{8}$	G $\frac{1}{8}$	M5	-	135.6	55	67
VSVA-B-...A2-R2L	107.8	81	36.5	18	18	20	20	17.4	5.6	4.3	G $\frac{3}{8}$	G $\frac{1}{8}$	G $\frac{1}{8}$	M5	M 8	121.8	111.8	67
VSVA-B-...A2-R5L	107.8	81	36.5	18	18	20	20	17.4	5.6	4.3	G $\frac{3}{8}$	G $\frac{1}{8}$	G $\frac{1}{8}$	M5	M12	121.8	111.8	67

	H4	H5	H6	H7	H8	H9	H10	H11	H12	L1	L2	L3	L4	L5	L6	L7	L8
VSVA-B-...A2	55	48	35.5	10.5	17	35.9	18.5	17	3.5	38 + nx 19	79.1	nx 19	19	7.5	13	4.5	1
VSVA-B-M52-...A2	55	48	35.5	10.5	17	35.9	18.5	17	3.5	38 + nx 19	79.1	nx 19	19	7.5	13	4.5	1
VSVA-B-...A2-R2L	55	48	35.5	10.5	17	35.8	18.5	17	3.5	38 + nx 19	79.1	nx 19	19	7.5	13	4.5	1
VSVA-B-...A2-R5L	55	48	35.5	10.5	17	35.8	18.5	17	3.5	38 + nx 19	79.1	nx 19	19	7.5	13	4.5	1

# Manifold components, ISO 15407-1

Technical data

FESTO

Dimensions – Manifold assembly, width 26 mm

Download CAD data → [www.festo.com](http://www.festo.com)

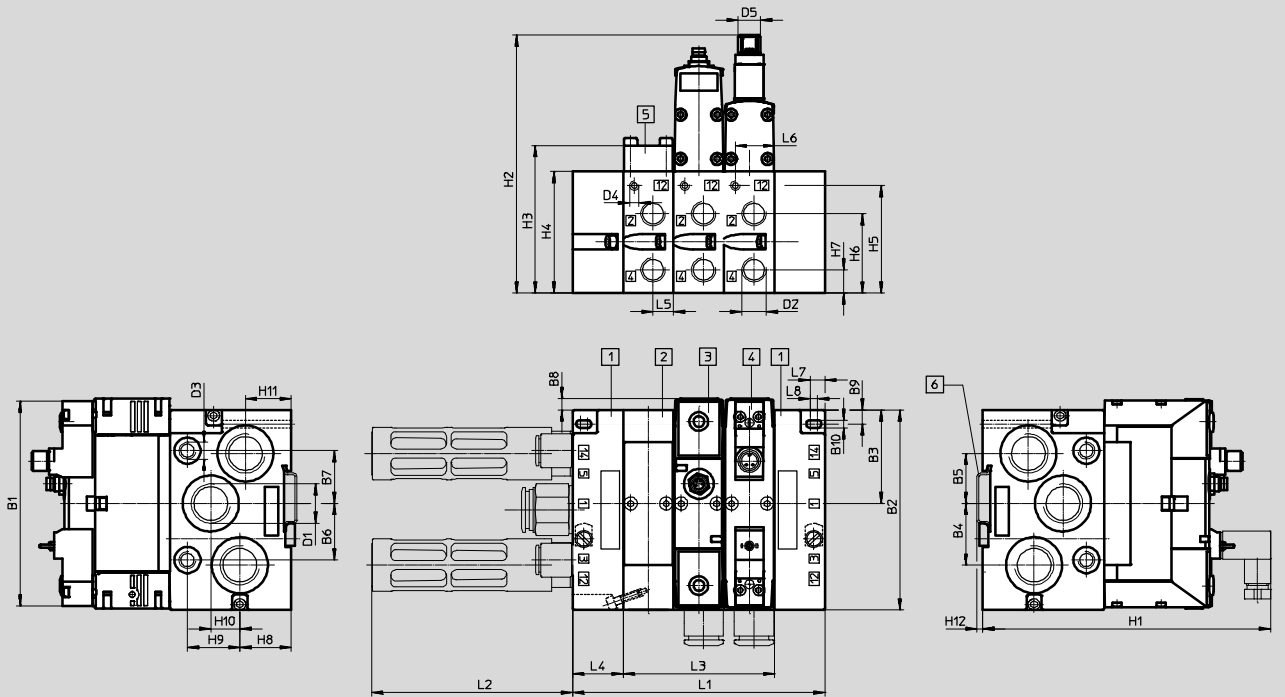

- 1 End plate kit type NEV-01-VDMA
- 2 Manifold sub-bases type NAW-¼-01-VDMA
- 3 Solenoid valve with central plug
- 4 Solenoid valve with pilot interface to ISO 15218
- 5 Blanking plate NDV-01-VDMA
- 6 Mounting rail NRH-35-2000
- 7 Solenoid valve with central plug
- 8 Solenoid valve with pilot interface to ISO 15218

	B1	B2	B3	B4	B5	B6	B7	B8	B9	B10	D1	D2	D3	D4	D5	H1	H2
VSVA-B-...A1	113.1	107	50	33	26.8	30.3	28.3	13.1	7.5	4.2	G½	G¼	G⅛	M5	-	154.2	65
VSVA-B-M52-...A1	126.2	107	50	33	26.8	30.3	28.3	13.1	7.5	4.2	G½	G¼	G⅛	M5	-	154.2	65
VSVA-B-...A1-R2L	112.5	107	50	33	26.8	30.3	28.3	6.3	7.5	4.2	G½	G¼	G⅛	M5	M8x 1	157	128.3
VSVA-B-...A1-R5L	112.5	107	50	33	26.8	30.3	28.3	6.3	7.5	4.2	G½	G¼	G⅛	M5	M12x 1	157	131.6

	H3	H4	H5	H6	H7	H8	H9	H10	H11	H12	L1	L2	L3	L4	L5	L6	L7	L8
VSVA-B-...A1	79	65	57.5	42.5	12.5	27.5	28	15.5	24.5	3.5	54 + nx 27	107.5	nx 27	27	11	21	8	4
VSVA-B-M52-...A1	79	65	57.5	42.5	12.5	27.5	28	15.5	24.5	3.5	54 + nx 27	107.5	nx 27	27	11	21	8	4
VSVA-B-...A1-R2L	79	65	57.5	42.5	12.5	27.5	28	15.5	24.5	3.5	54 + nx 27	107.5	nx 27	27	11	21	8	4
VSVA-B-...A1-R5L	79	65	57.5	42.5	12.5	27.5	28	15.5	24.5	3.5	54 + nx 27	107.5	nx 27	27	11	21	8	4

# Manifold components, ISO 15407-1

Technical data

FESTO

## Dimensions – Pressure regulator

Download CAD data → [www.festo.com](http://www.festo.com)

Width 18 mm with manifold sub-base and solenoid valve with central plug

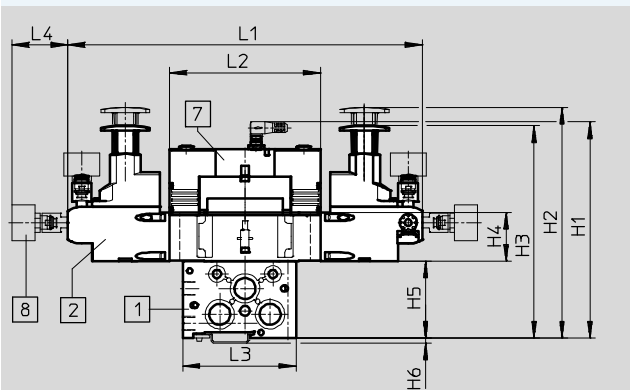

- 1 Manifold sub-base NAW
- 2 Regulator plate
- 7 Solenoid valve VSVA
- 8 Pressure gauge, freely positionable

Width 18 mm with manifold sub-base and solenoid valve with pilot interface to ISO 15218

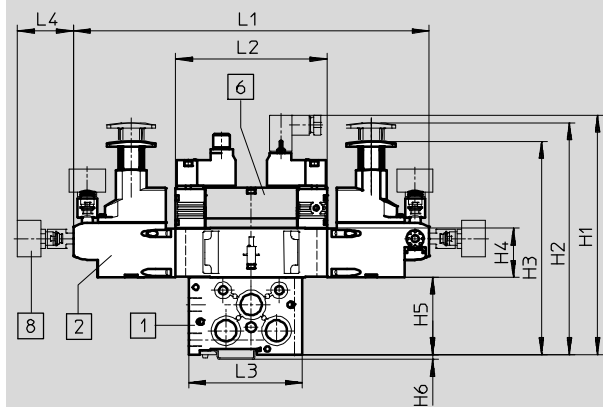

- 1 Manifold sub-base NAW
- 2 Regulator plate
- 6 Solenoid valve VSVA
- 8 Pressure gauge, freely positionable

Width 26 mm with manifold sub-base and solenoid valve with central plug

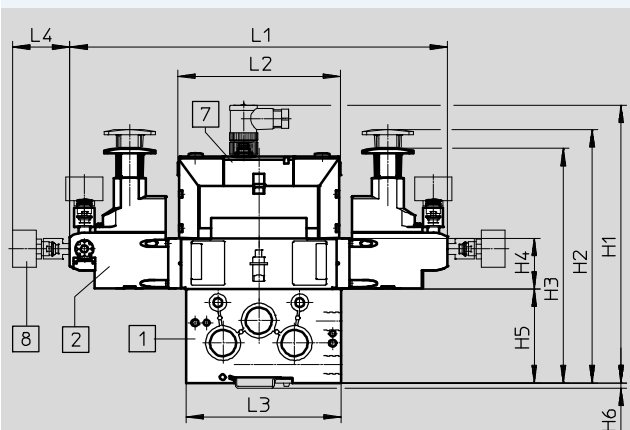

- 1 Manifold sub-base NAW
- 2 Regulator plate
- 7 Solenoid valve VSVA
- 8 Pressure gauge, freely positionable

Width 26 mm with manifold sub-base and solenoid valve with pilot interface to ISO 15218

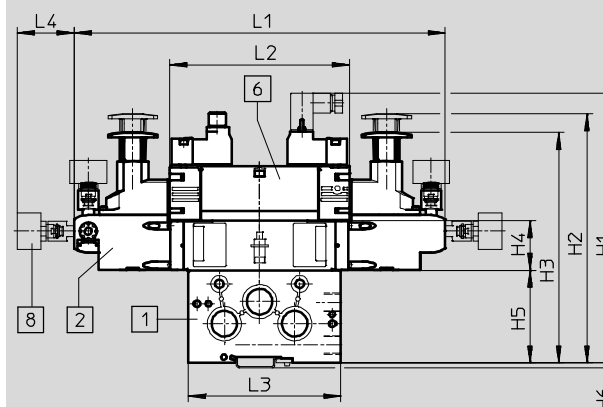

- 1 Manifold sub-base NAW
- 2 Regulator plate
- 6 Solenoid valve VSVA
- 8 Pressure gauge, freely positionable

Width [mm]	Solenoid valve	H1	H2	H3	H4	H5	H6	L1	L2	L3	L4
18	With central plug	156.8	165	152	35	55	3.5	253.4	107.8	81	39.8
	With pilot interface to ISO 15218	170.6									
26	With central plug	192	175	162	35	65	3.5	260.7	112.5	107	39.8
	With pilot interface to ISO 15218	189.6							126.2		

# Manifold components, ISO 15407-1

Technical data

## Dimensions – Flow control plate

Download CAD data → [www.festo.com](http://www.festo.com)

Width 18 mm with manifold sub-base and solenoid valve with central plug

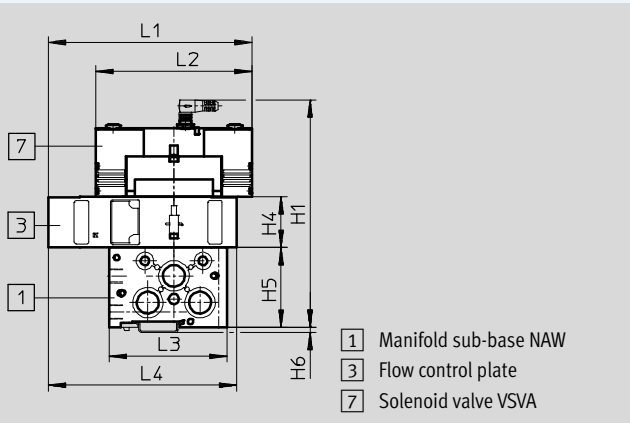

Width 18 mm with manifold sub-base and solenoid valve with pilot interface to ISO 15218

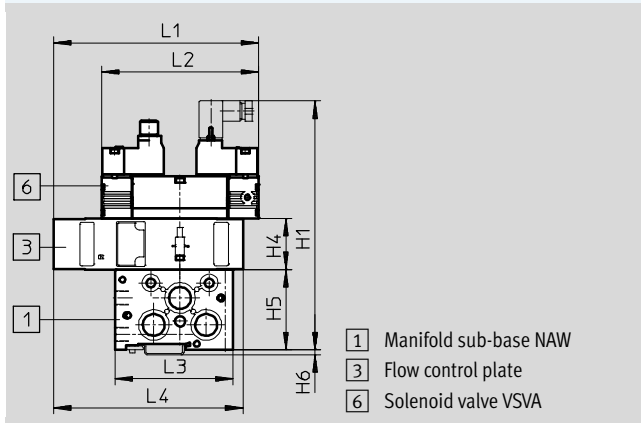

Width 26 mm with manifold sub-base and solenoid valve with central plug

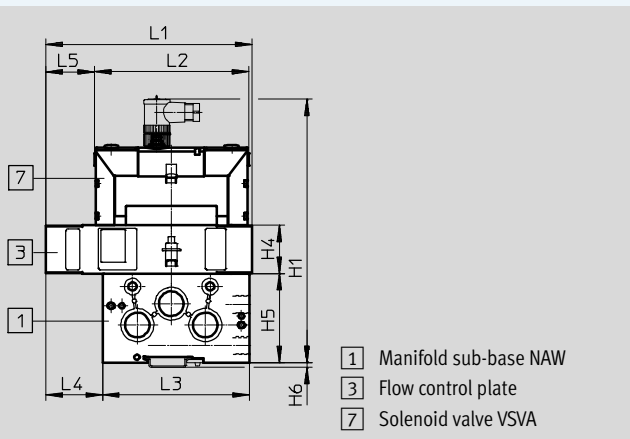

Width 26 mm with manifold sub-base and solenoid valve with pilot interface to ISO 15218

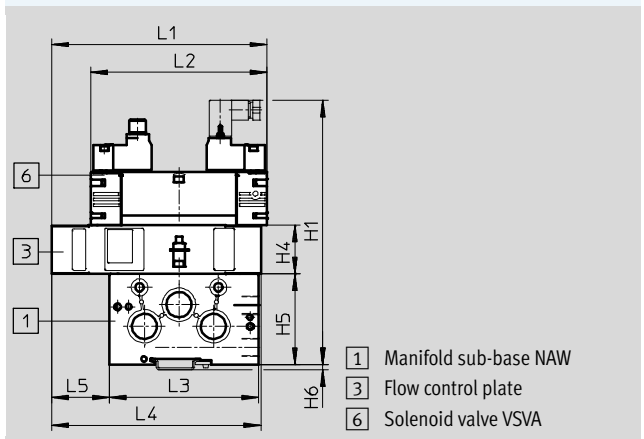

Width [mm]	Solenoid valve	H1	H4	H5	H6	L1	L2	L3	L4	L5
18	With central plug	156.8	35	55	3.5	140.8	107.8	81	130	-
	With pilot interface to ISO 15218	170.6								
26	With central plug	192	35	65	3.5	150	112.5	107	41.3	35
	With pilot interface to ISO 15218	189.6				154.4	126.2		150	41.3

# Manifold components, ISO 15407-1

Technical data

## Dimensions – Vertical supply plate

Download CAD data → [www.festo.com](http://www.festo.com)

Width 18 mm with manifold sub-base and solenoid valve with central plug

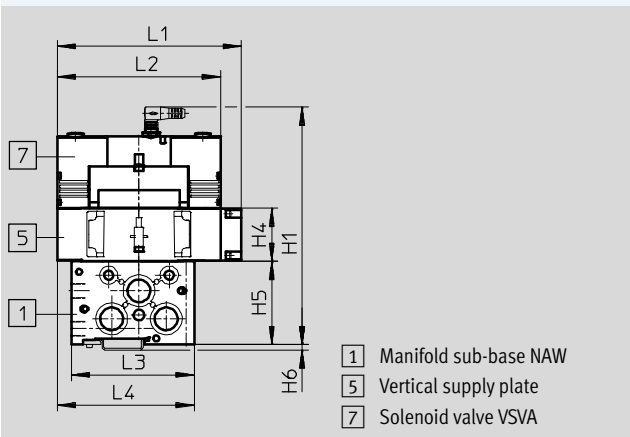

Width 18 mm with manifold sub-base and solenoid valve with pilot interface to ISO 15218

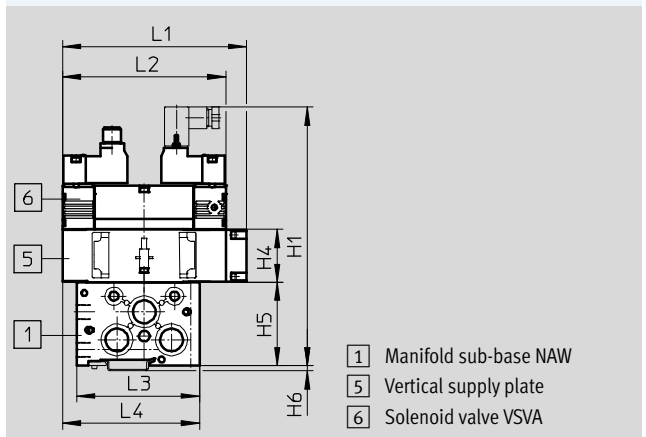

Width 26 mm with manifold sub-base and solenoid valve with central plug

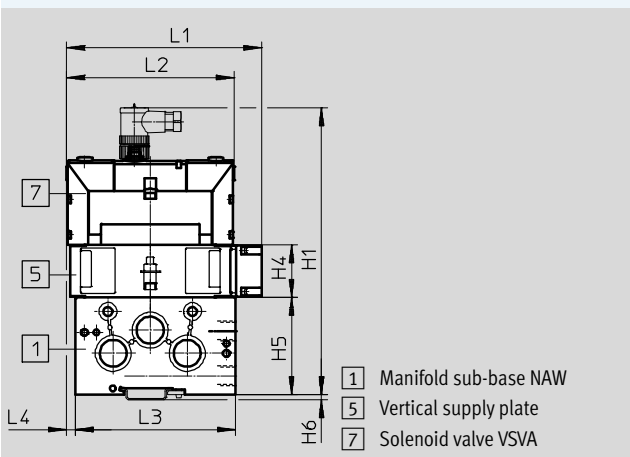

Width 26 mm with manifold sub-base and solenoid valve with pilot interface to ISO 15218

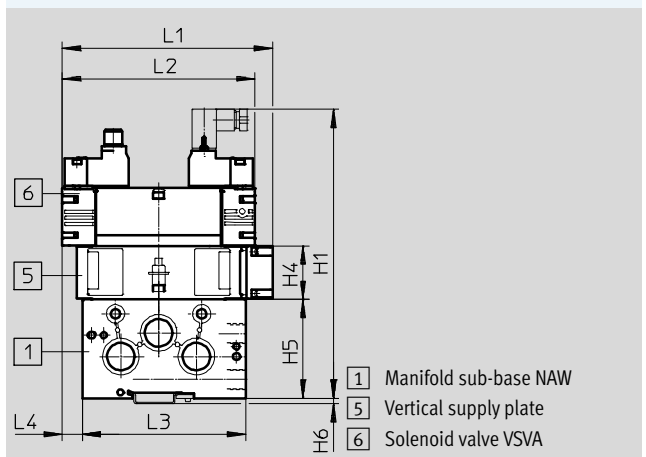

Width [mm]	Solenoid valve	H1	H4	H5	H6	L1	L2	L3	L4
18	With central plug	156.8	35	55	3.5	121.55	107.8	81	90.4
	With pilot interface to ISO 15218	170.6							
26	With central plug	192	35	65	3.5	130.8	112.5	107	6.3
	With pilot interface to ISO 15218	189.6							137.7

# Manifold components, ISO 15407-1

Technical data

FESTO

## Dimensions – Vertical pressure shut-off plate

Download CAD data → [www.festo.com](http://www.festo.com)

Width 18 mm with manifold sub-base and solenoid valve with central plug

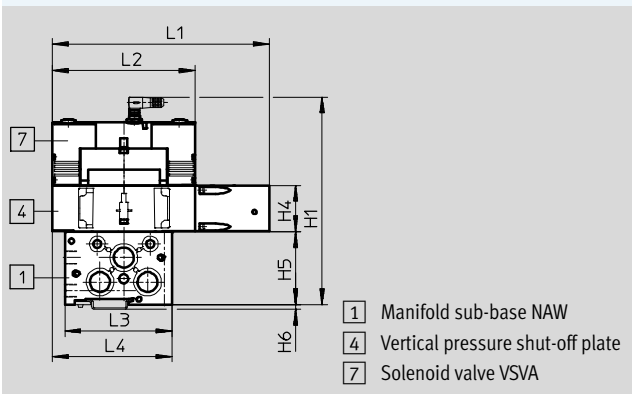

Width 18 mm with manifold sub-base and solenoid valve with pilot interface to ISO 15218

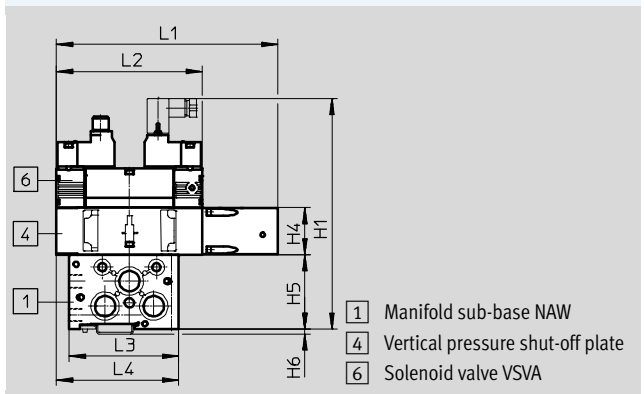

Width 26 mm with manifold sub-base and solenoid valve with central plug

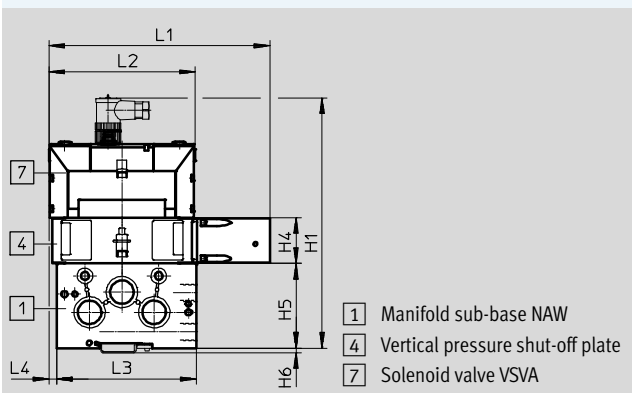

Width 26 mm with manifold sub-base and solenoid valve with pilot interface to ISO 15218

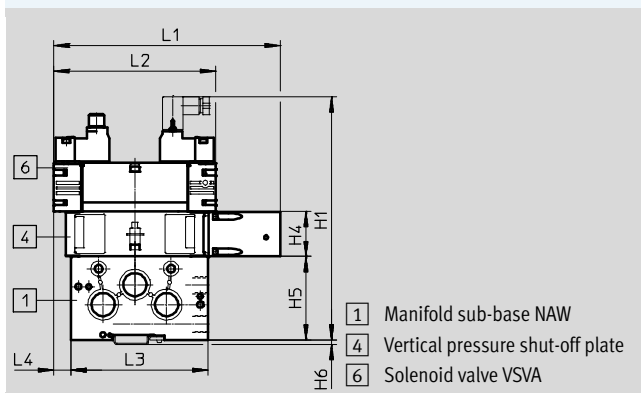

Width [mm]	Solenoid valve	H1	H4	H5	H6	L1	L2	L3	L4
18	With central plug	156.8	35	55	3.5	163.8	107.8	81	90.4
	With pilot interface to ISO 15218	170.6							
26	With central plug	192	35	65	3.5	169.7	112.5	107	6.3
	With pilot interface to ISO 15218	189.6							

# Solenoid/pneumatic valves, ISO 15407-1

Accessories

## Isolating disc NSC

Materials:  
Aluminium



Operating and environmental conditions	
Operating medium	Compressed air to ISO 8573-1:2010 [7:4:4]
Note on operating/pilot medium	Lubricated operation possible (in which case lubricated operation will always be required)

Ordering data				
Description	Width [mm]	Weight [g]	Part No.	Type
Isolating disc for ports 1, 3, 5 (solenoid/pneumatic valves)	18	2	161113	NSC-3/8-02-VDMA
	26	2	161105	NSC-1/2-01-VDMA
Isolating disc for ports 12, 14 (pneumatic valves)	18	2	161106	NSC-1/8-01-VDMA
	26	2	161106	NSC-1/8-01-VDMA

## Blanking plate NDV

Materials:  
Polymer  
Free of copper and PTFE

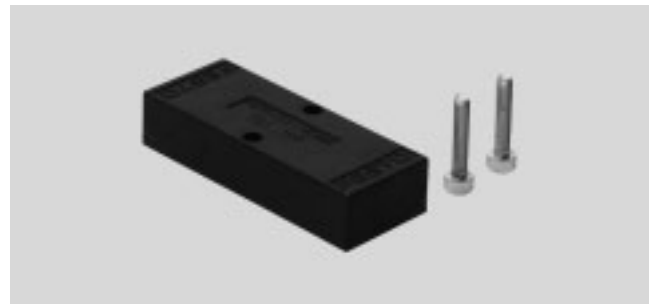



Operating and environmental conditions	
Operating medium	Compressed air to ISO 8573-1:2010 [7:4:4]
Note on operating/pilot medium	Lubricated operation possible (in which case lubricated operation will always be required)

Ordering data				
Description	Width [mm]	Weight [g]	Part No.	Type
Blanking plate to seal spare or vacant valve positions	18	22	161114	NDV-02-VDMA
	26	36	161107	NDV-01-VDMA

# Solenoid/pneumatic valves, ISO 15407-1

Accessories

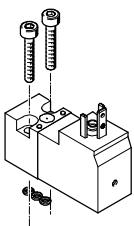
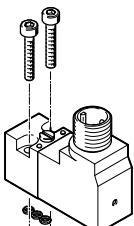





**FESTO**

Ordering data – Pilot valve to ISO 15218							
		Power		Voltage		Part No.	Type
		[W]	[VA]	[V DC]	[V AC]		
Plug, square, type C EN 175301-803							
	Manual override non-detenting	1.8	–	12	–	<b>546257</b>	<b>VSCS-B-M32-MH-WA-5C1</b>
				24		<b>546256</b>	<b>VSCS-B-M32-MH-WA-1C1</b>
		–	3.1/2.3	–	24	<b>546258</b>	<b>VSCS-B-M32-MH-WA-1AC1</b>
					110	<b>546259</b>	<b>VSCS-B-M32-MH-WA-2AC1</b>
					230	<b>546260</b>	<b>VSCS-B-M32-MH-WA-3AC1</b>
	Manual override, non-detenting/detenting	1.8	–	12	–	<b>571062</b>	<b>VSCS-B-M32-MD-WA-5C1</b>
				24		<b>571061</b>	<b>VSCS-B-M32-MD-WA-1C1</b>
		–	3.1/2.3	–	24	<b>571063</b>	<b>VSCS-B-M32-MD-WA-1AC1</b>
					230	<b>571065</b>	<b>VSCS-B-M32-MD-WA-3AC1</b>
					110	<b>571064</b>	<b>VSCS-B-M32-MD-WA-2AC1</b>
Plug M12 IEC 61076-2-101							
	Manual override, non-detenting/detenting	1.8	–	24	–	<b>573215</b>	<b>VSCS-B-M32-MD-WA-1R3</b>
	Manual override, detenting	1.8	–	24	–	<b>573214</b>	<b>VSCS-B-M32-MH-WA-1R3</b>
Tool for manual override							
	For manual override, detenting, with pilot valve VSCS-B-M32-MT					<b>157601</b>	<b>AHB-MEB</b>



# Solenoid/pneumatic valves, ISO 15407-1

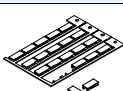







Accessories

Ordering data						
					Part No.	Type
Pressure gauge <span style="float: right;">Technical data → Internet: pagn</span>						
	With cartridge connection for regulator	0 ... 16 bar		<b>543487</b>	<b>PAGN-26-16-P10</b>	
		0 ... 10 bar		<b>543488</b>	<b>PAGN-26-10-P10</b>	
Cartridge for regulator plate						
	For tubing O.D.	4 mm	10 pieces	<b>172972</b>	<b>QSP10-4</b>	
Push-in fitting <span style="float: right;">Technical data → Internet: qs</span>						
	Connecting thread M5 for tubing O.D.	4 mm	10 pieces	<b>153315</b>	<b>QSM-M5-4-I</b>	
		6 mm	10 pieces	<b>153317</b>	<b>QSM-M5-6-I</b>	
	Connecting thread G $\frac{1}{8}$ for tubing O.D.	6 mm	10 pieces	<b>186096</b>	<b>QS-G<math>\frac{1}{8}</math>-6</b>	
		8 mm	10 pieces	<b>186098</b>	<b>QS-G<math>\frac{1}{8}</math>-8</b>	
	Connecting thread G $\frac{1}{4}$ for tubing O.D.	8 mm	10 pieces	<b>186099</b>	<b>QS-G<math>\frac{1}{4}</math>-8</b>	
		10 mm	10 pieces	<b>186101</b>	<b>QS-G<math>\frac{1}{4}</math>-10</b>	
	Connecting thread G $\frac{3}{8}$ for tubing O.D.	12 mm	10 pieces	<b>186103</b>	<b>QS-G<math>\frac{3}{8}</math>-12</b>	
		16 mm	1 piece	<b>186347</b>	<b>QS-G<math>\frac{3}{8}</math>-16</b>	
Connecting thread G $\frac{1}{2}$ for tubing O.D.	12 mm	1 piece	<b>186104</b>	<b>QS-G<math>\frac{1}{2}</math>-12</b>		
	16 mm	1 piece	<b>186105</b>	<b>QS-G<math>\frac{1}{2}</math>-16</b>		
Blanking plug <span style="float: right;">Technical data → Internet: b</span>						
	For sealing ports that are not required	For thread M5	10 pieces	<b>3843</b>	<b>B-M5</b>	
		For thread G $\frac{1}{8}$	10 pieces	<b>3568</b>	<b>B-<math>\frac{1}{8}</math></b>	
		For thread G $\frac{1}{4}$	10 pieces	<b>3569</b>	<b>B-<math>\frac{1}{4}</math></b>	
		For thread G $\frac{3}{8}$	10 pieces	<b>3570</b>	<b>B-<math>\frac{3}{8}</math></b>	
		For thread G $\frac{1}{2}$	10 pieces	<b>3571</b>	<b>B-<math>\frac{1}{2}</math></b>	
Silencers <span style="float: right;">Technical data → Internet: u</span>						
	For noise reduction at venting ports	For thread G $\frac{1}{8}$		<b>6841</b>	<b>U-<math>\frac{1}{8}</math>-B</b>	
		For thread G $\frac{1}{4}$		<b>6842</b>	<b>U-<math>\frac{1}{4}</math>-B</b>	
		For thread G $\frac{3}{8}$		<b>6843</b>	<b>U-<math>\frac{3}{8}</math>-B</b>	
		For thread G $\frac{1}{2}$		<b>6844</b>	<b>U-<math>\frac{1}{2}</math>-B</b>	
Inscription label <span style="float: right;">Technical data → Internet: ibs</span>						
	Inscription label, 9x20 mm, for valves	In frames	24 units	<b>18182</b>	<b>IBS-9x20</b>	
Inscription label holder <span style="float: right;">Technical data → Internet: ascf</span>						
	Clip-on inscription label holder for valve cap, for pneumatic valves VSPA		5 pieces	<b>540888</b>	<b>ASCF-T-S6</b>	

# Solenoid/pneumatic valves, ISO 15407-1

Accessories

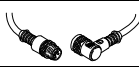

**FESTO**

Ordering data				Part No.	Type
Plug socket for port pattern to EN 175301-803, type C				Technical data → Internet: mssd	
	Via screw terminals	Cable connector Pg7		<b>151687</b>	<b>MSSD-EB</b>
		Cable connector M12		<b>539712</b>	<b>MSSD-EB-M12</b>
	With insulation displacement connection	Cable connector M14		<b>192745</b>	<b>MSSD-EB-S-M14</b>
Connecting cable for port pattern EN 175301-803, type C				Technical data → Internet: kmeb	
	With LED signal status display	24 V DC	2.5 m	<b>151688</b>	<b>KMEB-1-24-2,5-LED</b>
		24 V DC	5 m	<b>151689</b>	<b>KMEB-1-24-5-LED</b>
		24 V DC	10 m	<b>193457</b>	<b>KMEB-1-24-10-LED</b>
	Without signal status display	Up to 240 V	2.5 m	<b>151690</b>	<b>KMEB-1-230AC-2,5</b>
		Up to 240 V	5 m	<b>151691</b>	<b>KMEB-1-230AC-5</b>
Illuminating seal for port pattern EN 175301-803, type C				Technical data → Internet: meb-ld	
	For displaying the signal status	12 ... 24 V DC	–	<b>151717</b>	<b>MEB-LD-12-24DC</b>
		230 V AC	–	<b>151718</b>	<b>MEB-LD-230AC</b>
Plug sockets for valves, round plug M12x1				Technical data → Internet: sea	
	Angled socket, 4-pin, type A, screw terminal	Cable connector Pg7		<b>185498</b>	<b>SEA-M12-4WD-PG7</b>
Connecting cable for valves with round plug M8x1				Technical data → Internet: nebu	
	Straight socket, 4-pin Open cable end, 4-pin		2.5 m	<b>541342</b>	<b>NEBU-M8G4-K-2,5-LE4</b>
			5 m	<b>541343</b>	<b>NEBU-M8G4-K-5-LE4</b>
	Angled socket, 4-pin Open cable end, 4-pin		2.5 m	<b>541344</b>	<b>NEBU-M8W4-K-2,5-LE4</b>
			5 m	<b>541345</b>	<b>NEBU-M8W4-K-5-LE4</b>
Connecting cable for valves with round plug M12x1				Technical data → Internet: nebu	
	Straight plug, 4-pin Angled socket, 4-pin		1 m	<b>185499</b>	<b>KM-12-M12-GSWD-1-4</b>
			Straight socket, 5-pin Open cable end, 4-wire		2.5 m
	5 m			<b>541328</b>	<b>NEBU-M12G5-K-5-LE4</b>
Angled socket, 5-pin Open cable end, 4-wire			2.5 m	<b>550325</b>	<b>NEBU-M12W5-K-2,5-LE4</b>
			5 m	<b>541329</b>	<b>NEBU-M12W5-K-5-LE4</b>

# Solenoid/pneumatic valves, ISO 15407-1

Accessories

**FESTO**

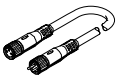
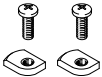
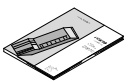
Ordering data			Part No.	Type
Connecting cable for electrical connection of the switching status sensor				
	Straight socket, M8x1, 3-pin Open end, 3-wire	2.5 m	<b>541333</b>	<b>NEBU-M8G3-K-2,5-LE3</b>
		5 m	<b>541334</b>	<b>NEBU-M8G3-K-5-LE3</b>
	Angled socket, M8x1, 3-pin Open end, 3-wire	–	<b>541338</b>	<b>NEBU-M8W3-K-2,5-LE3</b>
		5 m	<b>541341</b>	<b>NEBU-M8W3-K-5-LE3</b>
	Rotatable socket	2.5 m	<b>8001660</b>	<b>NEBU-M8R3-K-2.5-LE3</b>
		5 m	<b>8001661</b>	<b>NEBU-M8R3-K-5-LE3</b>
	Straight socket, M8x1, 3-pin Straight plug, M8x1, 4-pin	2.5 m	<b>554037</b>	<b>NEBU-M8G3-K-2,5-M8G4</b>
H-rail mounting				
	For end plate width 18 mm	2 pieces	<b>553996</b>	<b>VAME-S3-2-H</b>
	For end plate width 26 mm	2 pieces	<b>553995</b>	<b>VAME-S3-1-H</b>
User documentation				
	Valve manifold VTIA	German	<b>538928</b>	<b>P.BE-VTIA-DE</b>
		English	<b>538929</b>	<b>P.BE-VTIA-EN</b>
		French	<b>538931</b>	<b>P.BE-VTIA-FR</b>
		Spanish	<b>538930</b>	<b>P.BE-VTIA-ES</b>
		Italian	<b>538932</b>	<b>P.BE-VTIA-IT</b>